

Arbiton
FLOOR EXPERT



**BEAUTIFUL AS WOOD,
PRACTICAL AS CERAMIC TILES**



MORE THAN JUST A FLOOR



25 YEARS INVESTING IN FUTURE

Innovation, quality and know-how: since 1994 we've been investing in knowledge, technology and our machinery park. 25 years we create and improve our product portfolio. We aim to become market LEADER wherever we are present. We provide solutions for the most demanding floor users. We share experience and set trends.

**We try harder, we are
the FLOOR EXPERT.**

Decora S.A.





TABLE OF CONTENT

- 06 **BEAUTIFUL AS WOOD
PRACTICAL AS CERAMIC TILES**
ALL YOU NEED TO KNOW ABOUT
OUR HD MINERAL CORE FLOORING
- 20 **ONE SPACE ONE FLOOR**
ALL YOU NEED TO KNOW ABOUT
SIZE AND INSTALLATION
- 26 **BE INSPIRED**
ALL YOU NEED TO KNOW ABOUT LATEST
INTERIOR DESIGN TRENDS
- 56 **FLOORING COLLECTIONS**
ALL YOU NEED TO KNOW ABOUT
OUR COLLECTIONS:
AMARON WOOD DESIGN COLLECTION / 56
AMARON STONE DESIGN COLLECTION / 72
LIBERAL COLLECTION / 78
AROQ WOOD DESIGN COLLECTION / 92
AROQ STONE DESIGN COLLECTION / 100
- 108 **DESIGN IS IN THE DETAIL**
ALL YOU NEED TO KNOW ABOUT
DEDICATED FLOOR ACCESSORIES
- 124 **FLOORING TECHNICAL PARAMETERS**

HD MINERAL CORE®



In our laboratories we've discovered an innovative combination of natural rock minerals and advanced polymers. Carefully selected proportion ensures maximum performance of the floor. Our HD mineral core provides extreme durability what have confirmed by giving 20 year guarantee. We are proud of the quality of our products free of phthalates and harmful plasticizers.



HARDNESS AND DURABILITY OF NATURAL ROCK MINERALS

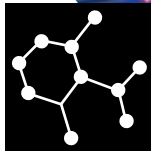
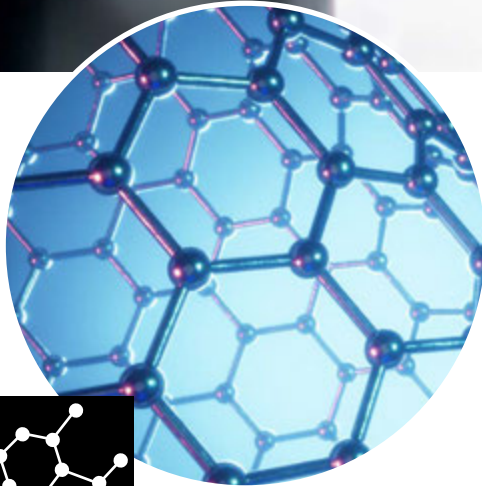

THE FLEXIBILITY OF MODERN POLYMERS BASED ON CARBON MOLECULES

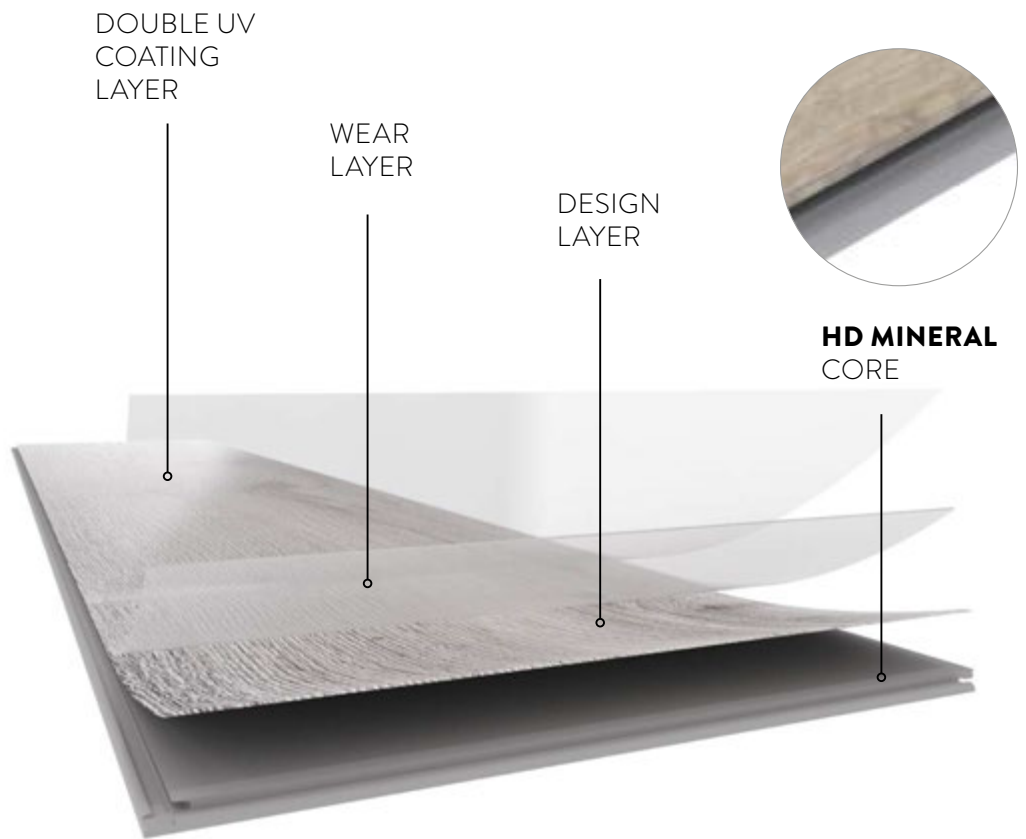

15^{*}
YEARS
GUARANTEE
RESIDENTIAL

20^{*}
YEARS
GUARANTEE
RESIDENTIAL

* 15 years
guarantee for
LIBERAL
Collection

* 20 years
guarantee for
AMARON
Collections
and AROQ
Collections

MORE THAN JUST ECO

ARBITON ECO STATEMENT

MOUNTAINS OF GARBAGE LITTER OUR PLANET. DISPOSABLE, LOW-QUALITY AND ARTIFICIAL AGING PRODUCTS ARE TO BLAME.

IT'S NOT PLASTIC AS A RAW MATERIAL, BUT OUR APPROACH TO THINGS WE USE.

THE SOLUTION IS NOT TO ELIMINATE PLASTICS, BUT TO CONSCIOUSLY AND RESPONSIBLY USE, RECYCLE AND REUSE.

HIGH-QUALITY, LONGLIVED PRODUCTS THAT ARE 100% RECYCLABLE GUARANTEE THE FUTURE SAFETY OF OUR CHILDREN.

REDUCE, REUSE, RECYCLE

THEREFORE, UNDER THE ARBITON BRAND YOU WILL FIND ONLY PRODUCTS THAT WILL SERVE YOU FOR MANY YEARS, SUCH AS A VINYL FLOOR WITH A MINERAL CORE, FOR WHICH WE GIVE A 20 YEAR WARRANTY.

LET'S GO BACK TO THE TIMES WHERE THINGS LASTED FOR MANY YEARS.



A photograph of two hikers walking away from the camera on a dirt path in a forest. The hiker on the left wears a wide-brimmed straw hat, a blue and white plaid shirt, and a large tan backpack with a rolled-up sleeping bag and a metal cup. The hiker on the right wears a tan pith helmet, a red and white plaid shirt, and a large tan backpack with a rolled-up sleeping bag, a lantern, and a small brown bag. The background is a soft-focus forest with tall trees and green foliage.

**REDUCE
REUSE
RECYCLE**

**ARBITON MINERAL CORE FLOORS ARE
100% SAFE, 100% RECYCLABLE AND
MOST IMPORTANTLY STAYS FOR
MANY YEARS.**

TITANIUM NANO-LAYER

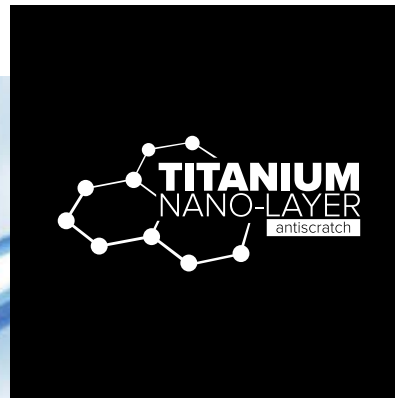

The Arbiton Mineral Core flooring collection has been protected by an additional Titanium Nano Layer protective coating that creates an imperceptible, but very durable layer, making the floor even more resistant to scratches.

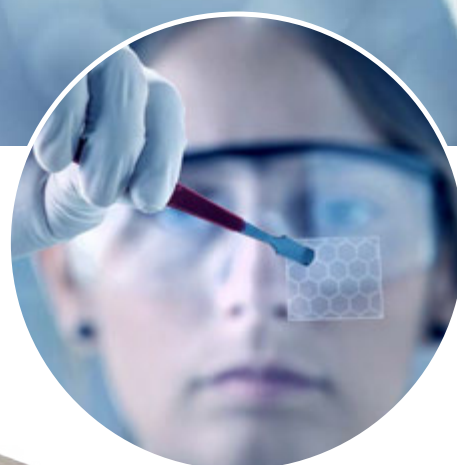



**30% MORE
RESISTANT
SURFACE***



FLOOR WITH
TITANIUM NANO LAYER



STANDARD LVT

* test method according to EN1518

**BEAUTIFUL
AS
WOOD**







REAL WOOD STRUCTURE

Unique and realistic wood design
selected from the most beautiful wood
type in the world.



WIDE BOARD

The widest plank available on the market
- 229 mm - beautiful and the most natural
looking floor.



SOFT TOUCH

Soft, delicate and mat finished flooring - the best representation of a real wood.



SILENT FLOOR

Nice and silent in everyday use vinyl flooring brings comfort and serenity to everyday life.

PRACTICAL AS CERAMIC TILES

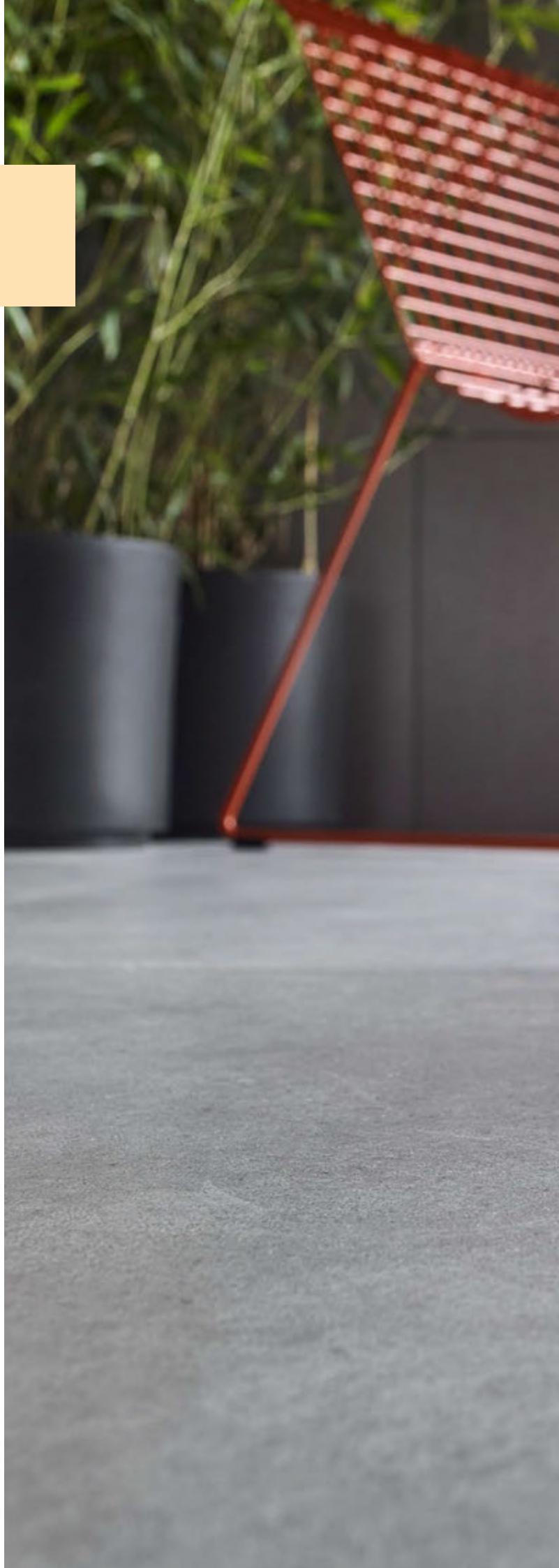





LOCKING STRENGTH
(ISO 24334)

AMARON

Long Side 5,2 kN/m

End Face 6,5 kN/m

LIBERAL

Long Side 5,0 kN/m

End Face 6,2 kN/m

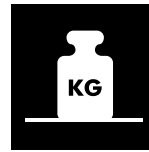

DURABILITY + STRONGER

LOCKING SYSTEM

HD Mineral Core primarily means extremely strong locking system what gives the whole flooring system a maximum durability. Despite of small thickness of the plank our locks are 2 times stronger than average LVT locks available on the market.



WATERPROOF

No need to be scared of water. Our floors are 100% waterproof. Frequent cleaning or spilled drinks are no longer dangerous to your floor. Without concerns you can connect your kitchen floor with the rest of your living space.

100% WATERPROOF



UNDERFLOOR HEATING

Very low thermal resistance of our floors means more effective use of the underfloor heating system. Thanks to HD Mineral Core less fuel is needed for floor heating and over 60% less carbon is released into the atmosphere from one household in Europe, each year.

THERMAL RESISTANCE

(EN 12664) up to 0,033 m²K/W

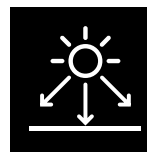

DIMENSIONAL STABILITY

HD Mineral Core also means high dimensional stability of the floor even in very sunny rooms. We offer at least 2 times higher dimensional stability of our floors in comparison to traditional LVT.

DIMENSIONAL STABILITY

(EN ISO 23999) up to 0,05%

ONE SPACE ONE FLOOR

Thanks to its usability our floor is dedicated to open space interiors. Open kitchen with living room is a heart of your home and with our **HD Mineral Core** solution your floor will stay strong and beautiful for years.



UP TO 200 m²
WITHOUT DILATATION

* see installation manual



LIVING ROOM

KITCHEN



HALL

SIZE DOES MATTER

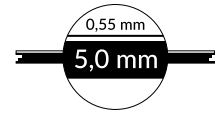

AMARON
XXL STONE DESIGN

NEW

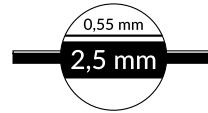
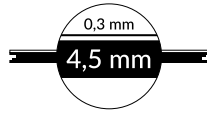

Our floors come in different shapes and sizes, but what's really important - our AMARON and LIBERAL planks are the widest available on the market.

AMARON
WOOD DESIGN

LIBERAL

AROQ
WOOD DESIGN

AROQ
STONE DESIGN

**IT
CAN'T
BE
EASIER**



**WATCH
THE INSTALLATION
VIDEOS ON**

www.youtube.com/Arbiton



CA 114 | Williamsburg Oak

AMARON COLLECTION

STRONG & SILENT

CLICK
FLOOR



5G® LOCKING SYSTEM is based on a single action installation method. The boards are locked on the long side with a traditional angling method. When a panel is folded down, a flexible plastic tongue is pushed into a tongue-groove. As the panel reaches its final position, the locking tongue snaps out into a wedge groove, emits a click sound and locks the product vertically. Floor installation has never been easier.

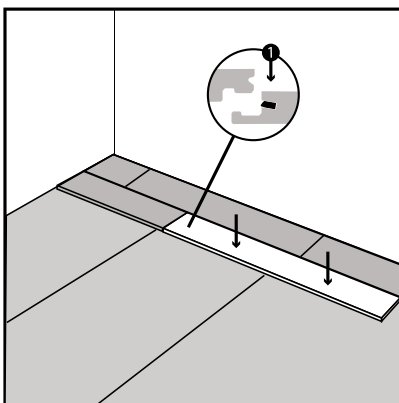
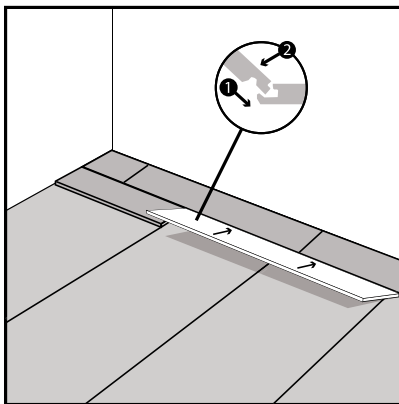

LIBERAL COLLECTION

STRONG & SILENT

CLICK
FLOOR



2G® LOCKING SYSTEM is a strong and durable mechanical locking system installed by angling. Suitable for all panel widths, vertical and horizontal locking. Robust and easy floor installation.

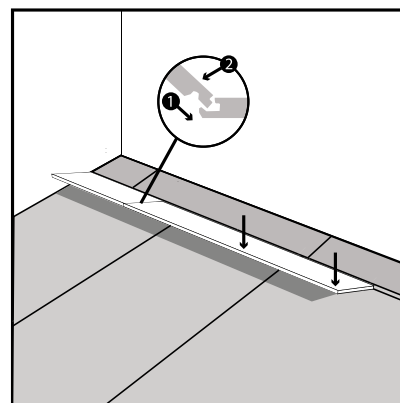
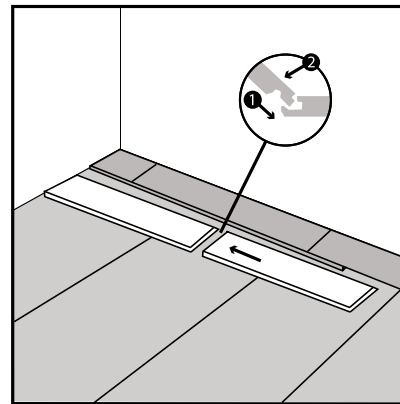



BE
INSPIRED

YOUR DESIGN,
OUR FULL RIGID
MINERAL CORE
FLOORING



MORE
THAN *twenty*
TRENDBOOK 20/21

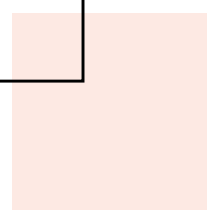

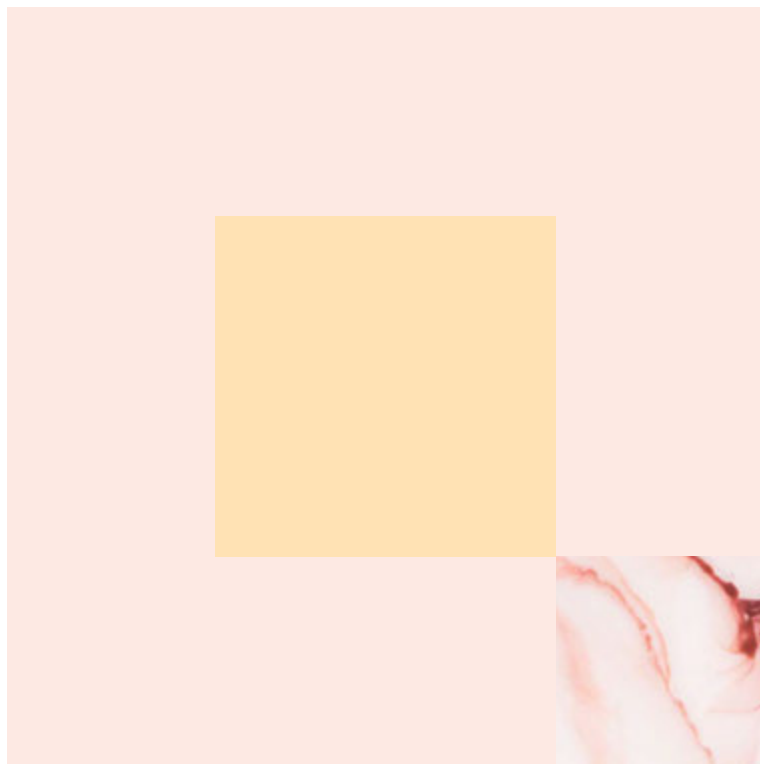



OPEN SPACE

Universal access to education, information and design has never been easier. Democracy is prevailing and movements for equal rights have strong voice. Cultures have merged and unified - MIX & MATCH - take elements you like, blend, experiment and find your own combination. This freedom of expression causes an unprecedented explosion of diversity. It is difficult to talk about subcultures nowadays, as each individual has developed its own subculture. We are not talking today about the cult of idols, adored and admired by millions. Now, anyone can be a star. For a short while, but still. Everyone has unlimited access to the media. You don't have to take part in a talent or reality show on TV, because you can create one for yourself using free social media tools. Paradoxically, even nationalist movements are a consequence of the growing freedom and inability of individuals to cope with it.





LESS BARRIERS, LESS WALLS



CA 151 | Baker Concrete

These changes affect architecture and design. The layout of the rooms and their purpose is changing. This is vivid when you see modern kitchen, which has become part of the living room. It is the heart of home, a place for work, social gatherings, a place to spend time. The same areas are adapted to perform several functions. Less and less walls in our homes, more and more light and openness. Just as we do many things at once, our environment must be prepared to keep up.

How are design trends being shaped in this environment? Fast! Trends lifetime has reduced. From showing up in one neighborhood to adaptation in the entire world passes weeks or days, not seasons. Everything happens in parallel. We cannot any longer talk about trends in terms of the 20th century. Today it is not about the fashionable color of the walls, but about the philosophy. Our holistic approach to life, the objects that surround us and the environment we live in - these are the places to look for the trends.

MIX & MATCH



> rounded shapes for furniture and lighting systems, but also walls



> color, but not necessarily intense
 > pastels (millennial pink, lavender, coral, marigold)
 > dark rooms with expressive floral motifs



THE COMBINATION OF COLOURS, TEXTURES, MATERIALS, A FUSION OF OLD AND MODERN.

The quintessence of open space, the idea of combining, culture of mixing, and turning old styles to new life, using them in a new way. A multiplicity of which maximalism is an extreme emanation. The idea of faith in the human individuality and its uniqueness. And the similarities can be noticed in diversity.



> 'back to the 70's' style

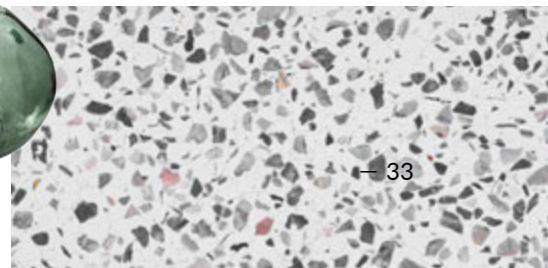

AMARON collection | Wellington Oak





> geometric elements
in decorations,
geometric motifs on
carpets

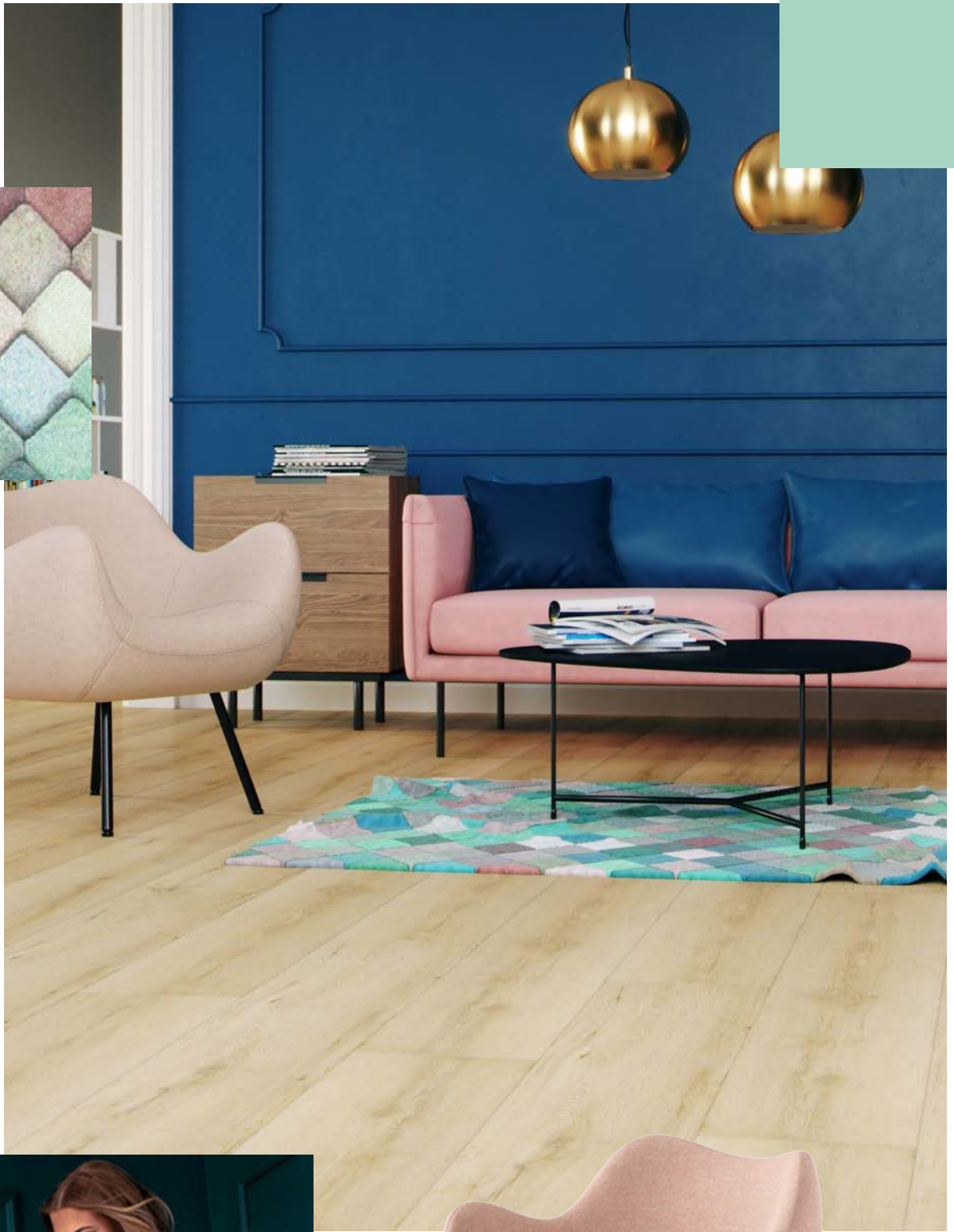

> a combination of natural (leather, wood,
metal) and artificial materials

BOHO



> patchwork - combining different textures and colors



COMING FROM THE FRENCH "BOHEMIAN", ARTISTIC, SOULFUL AND ORIGINAL. A MIX OF CULTURES, STYLES AND ERAS.

Here, the uniqueness is also sought in art, therefore graphics and sculptures play an important role, freedom of the spirit in the interior, Middle Eastern designs combined with ethnic geometric patterns. All accessories demonstrating the inhabitants' interest in culture and art are welcome, that's why musical instruments, old cameras, albums and easels appear.



> souvenirs from distant travels on the walls, shelves



> decorative elements made of rattan, grass, rough wood

LIBERAL collection | Pasadena Oak



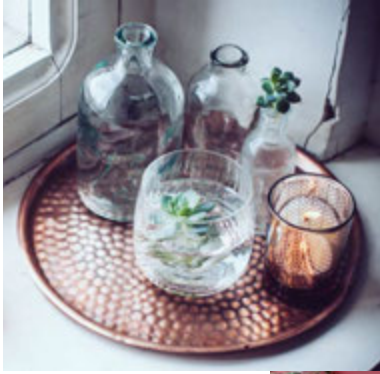

> style overloaded with patterns and colors, the opposite of minimalism

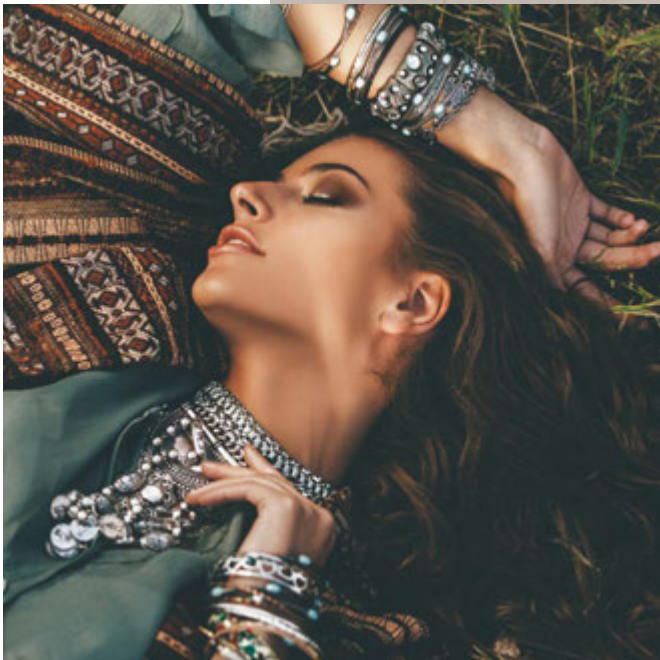

> fabrics - in bold designs and colors, a variety of structures

NEW YORK
STYLE



> synthetic, geometric form
> operating with straight lines



NEW YORK'S ELEGANCE AND STYLE, DELIGHT IN INDUSTRIAL DESIGN, UTILITARIANISM, CLEAN LINES AND SYMMETRY OF FORM.

The triumphant return of the first style, which has become a global fashion at the beginning of the 20th century. Classic modernity, aesthetics originally combining modernism, corresponding to economic progress with classic, symmetrical forms. Today it is synonymous with timeless elegance. Elegance of furniture, high quality of natural materials - marble, granite combined with the rawness of copper. White as an addition in the form of flowers or as a universal background. Fashionable combination of black color and gold, geometric decorations. Heavy, flowing, slightly shiny fabrics in the windows. Stylized posters on Łempicka's paintings.

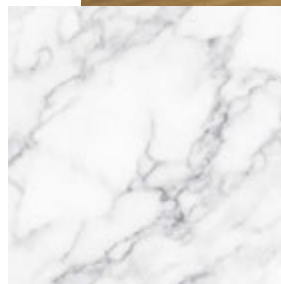

> solid forms
> strict rules of composition and symmetry



AMARON collection | Georgetown Oak





> heavy, flowing, slightly shimmering materials



> fabrics - in bold designs and colors, a variety of structures

ENDLESS
SUMMER

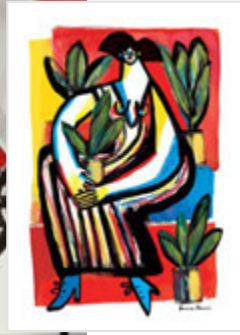

designed by Basia Flores



> energetic colors



FOREVER YOUNG, NOT PERMANENTLY RELATED TO ANY PLACE.

Young at heart, always free, contemporary nomads. Experience beyond possessions. They live here and now, surround themselves with items they use every day. Instead of sculpture, room adorned with stylish cycling. They reject great, massive brands, appreciate handicrafts and elitism. A bit moralizing, intellectual group. The essence of style are streetwear brands from Supreme, BAPE. Above all, things and interiors are useful for them.



> above all useful items



vzor RM57

> elements related to mobility: surfboard, bicycle

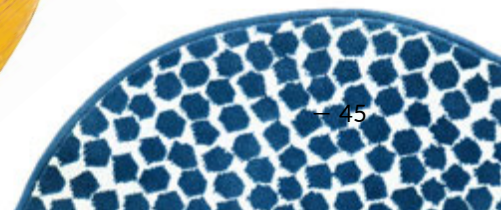

LIBERAL collection | Alaskan Oak





> living here and now,
quickly, specifically,
mobile



vzor GRID35



designed by Basia Flores

MY HOME
MY CASTLE



> warmth enchanted in wood
 > natural and ecological materials



WHERE IS A THESIS THERE, IS ALSO AN ANTITHESIS.

Like yin and yang. If on one hand we have mix and variety, on the other hand there will be orderly minimalism. Sometimes the amount of stimuli is so large that it triggers a defence mechanism, the need to build your own fortress and protection against the "attacking world". CASTLE, is a natural of calmness, coziness. A kind of solitude, opened to nature. Rich vegetation, natural, warm wooden colors, but above all a limited number of elements and their versatility. One place, many applications - hybrid space. Reaction to small spaces in urban apartments. In response to the flood of cheap, disposable items which lifespan is shorter with each subsequent series, CASTLE means the return to permanent, timeless things.

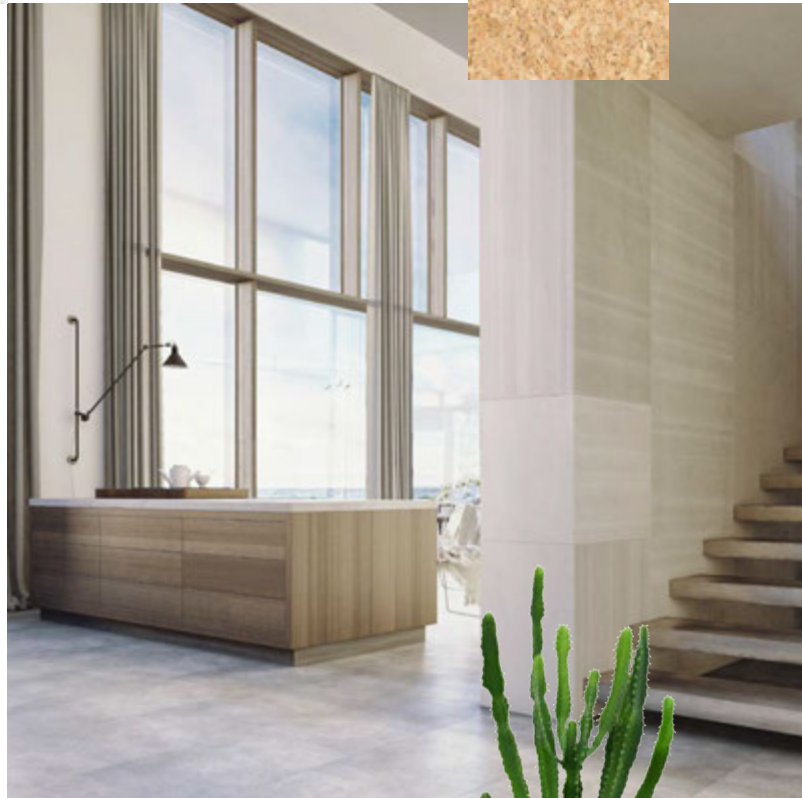

AMARON collection | Panama Oak





> minimalism expressed
in form and materials -
concrete, wood, stone



vzor RM56

ZEN



> a combination of sensitivity, airiness, evanescence with durability and timelessness



PEACE OF MIND, ORDER, TIMELESS

The secret to the longevity of the people of Okinawa, taking advantage of the forces of nature, not fighting them. Appreciation of natural colors, materials and textures. There is no way to the happiness, happiness is the way. The beauty of rituals, absolute consecration to the moment without waiting for the effect. Striving for perfection, focusing on improving skills as a value, appreciating the present, being here and now. Quality over quantity, simple, harmonious and disciplined space. Usability above all. The commercial emanations of this style are MUJI or UNIQLO products.



> imperfection of nature, aesthetics of ugliness



> order, peace, satisfaction from here and now







> simplicity, balance



vzor RM57



AMARON WOOD DESIGN

Amaron WOOD means expressive designs, which will create the character of the interior. The floors in this collection have the highest usage class, created for the most demanding customers. This floor will play first fiddle.

The 5G lock makes the floor easy and fast to install.

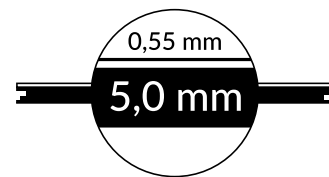
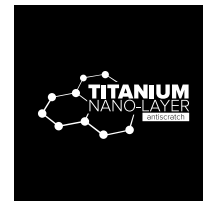

WATCH

THE INSTALLATION VIDEOS ON
www.youtube.com/Arbiton

CA 154 | Sierra Oak

AMARON WOOD DESIGN

ALASKAN OAK



CA 102 / EAN: 5905167798508 / Plank size: 1511 mm x 229 mm

1 BOX = 6  = 2,08 m²

AMARON WOOD DESIGN

LAHTI OAK



1 BOX = 6  = 2,08 m²

CA 117 / EAN: 5905167798553 / Plank size: 1511 mm x 229 mm

AMARON WOOD DESIGN

OREGON OAK



CA 115 / EAN: 5905167798539 / Plank size: 1511 mm x 229 mm

1 BOX = 6  = 2,08 m²

AMARON WOOD DESIGN

ARGOS OAK



1 BOX = 6  = 2,08 m²

CA 116 / EAN: 5905167798546 / Plank size: 1511 mm x 229 mm

AMARON WOOD DESIGN

WELLINGTON OAK

DEEP BEVELS 

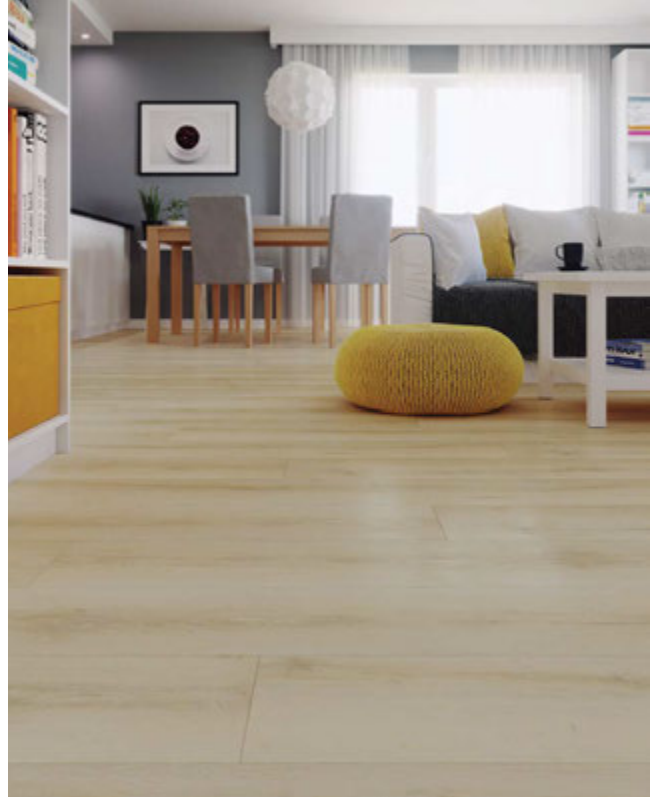

CA 145 / EAN: 5905167814871 / Plank size: 1511 mm x 229 mm

1 BOX = 6  = 2,08 m²

AMARON WOOD DESIGN

PANAMA OAK

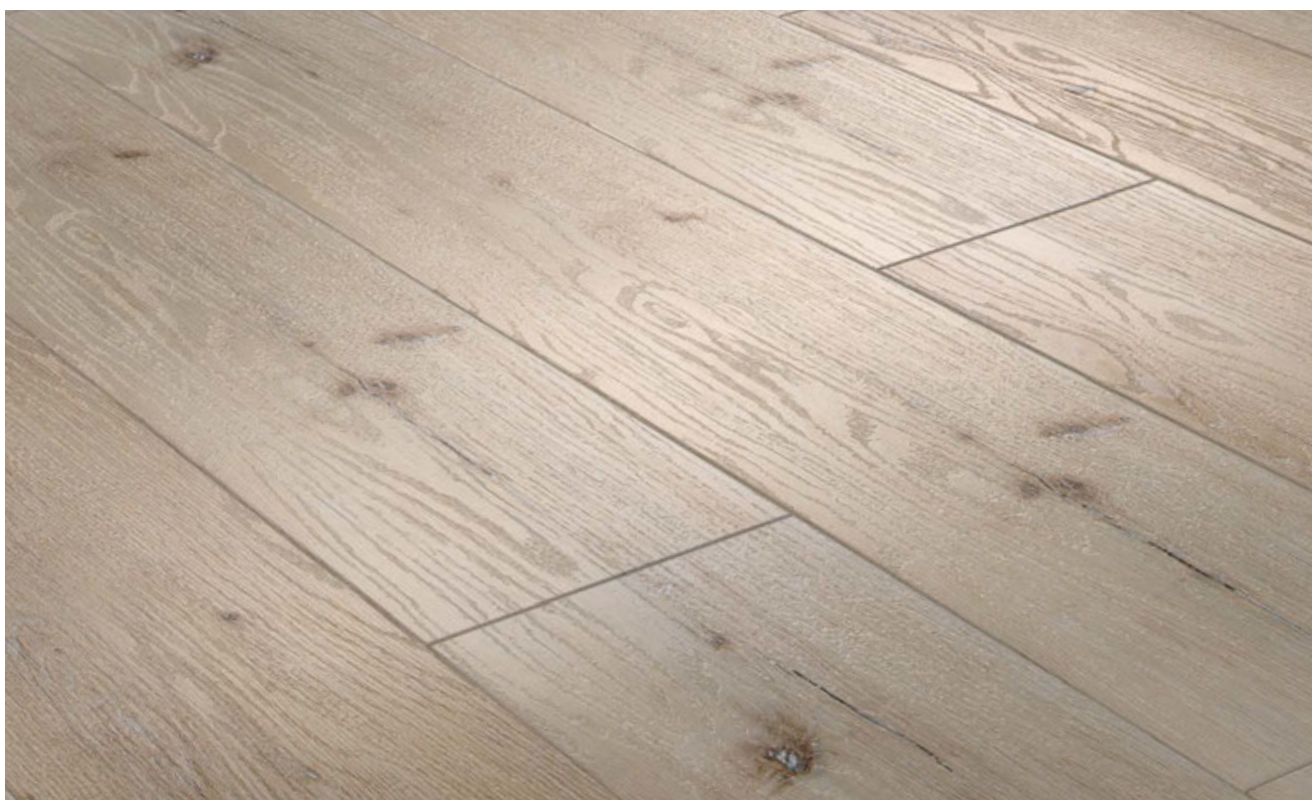

1 BOX = 6  = 2,08 m²

CA 113 / EAN: 5905167798515 / Plank size: 1511 mm x 229 mm

AMARON WOOD DESIGN
YANKEE OAK
NEW

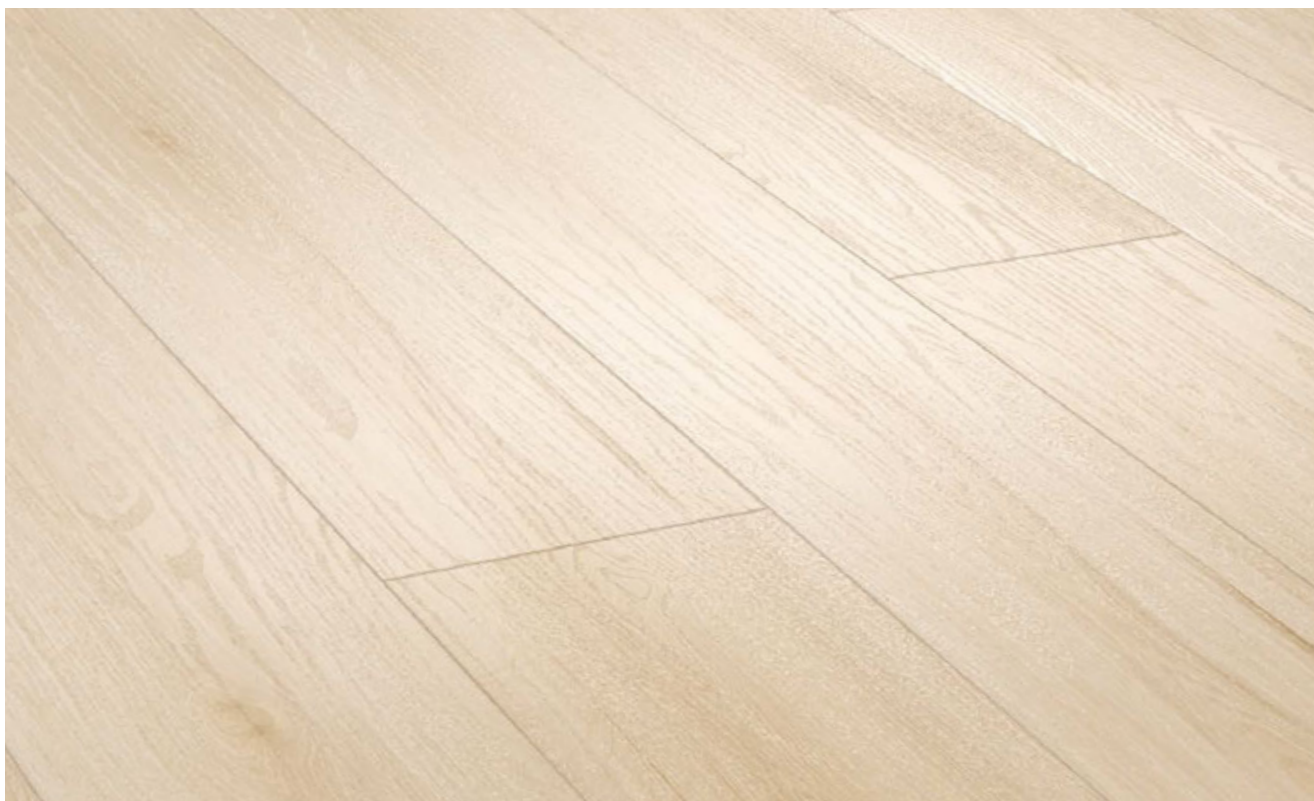

CA 153 / EAN: 5905167824191 / Plank size: 1511 mm x 229 mm

1 BOX = 6  = 2,08 m²

AMARON WOOD DESIGN

SIERRA OAK

NEW



1 BOX = 6  = 2,08 m²

CA 154 / EAN: 5905167824207 / Plank size: 1511 mm x 229 mm

AMARON WOOD DESIGN

BELFORD OAK

DEEP BEVELS 

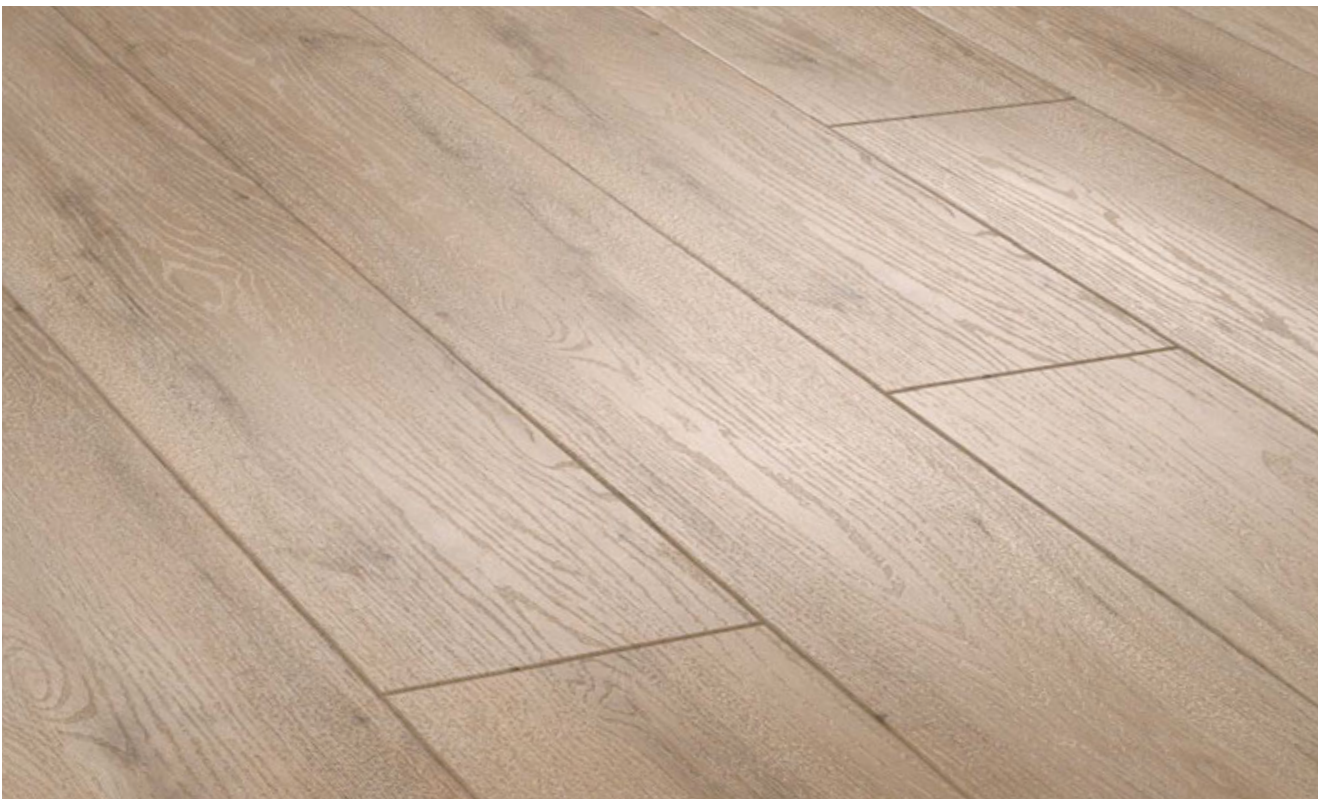

CA 146 / EAN: 5905167814888 / Plank size: 1511 mm x 229 mm

1 BOX = 6  = 2,08 m²

AMARON WOOD DESIGN

WILIAMSBURG OAK



1 BOX = 6  = 2,08 m²

CA 114 / EAN: 5905167798522 / Plank size: 1511 mm x 229 mm

AMARON WOOD DESIGN

GEORGETOWN OAK

DEEP BEVELS 



CA 147 / EAN: 5905167814895 / Plank size: 1511 mm x 229 mm

1 BOX = 6  = 2,08 m²

AMARON WOOD DESIGN

MAYNE OAK

NEW



1 BOX = 6  = 2,08 m²

CA 155 / EAN: 5905167824214 / Plank size: 1511 mm x 229 mm

AMARON WOOD DESIGN

GRANTS OAK

DEEP BEVELS 



CA 148 / EAN: 5905167814901 / Plank size: 1511 mm x 229 mm

1 BOX = 6  = 2,08 m²





XXL AMARON STONE DESIGN

Amaron STONE is a collection in concrete colors, big size of panels and modern industrial colors, gives your interior an original and modern character. The floors in this collection have the highest usage class, created for the most demanding customers. The 5G lock makes the floor easy and fast to install.

20 years of warranty.



CA 149 | Glacier Concrete

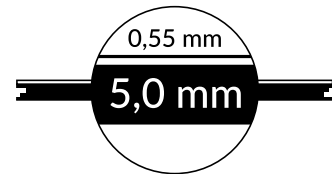
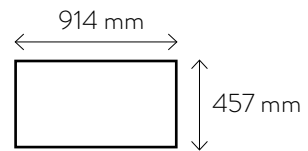
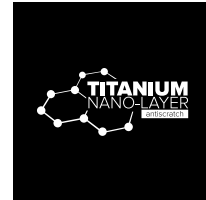

WATCH

THE INSTALLATION VIDEOS ON
www.youtube.com/Arbiton

AMARON XXL STONE DESIGN

GLACIER CONCRETE

DEEP BEVELS 

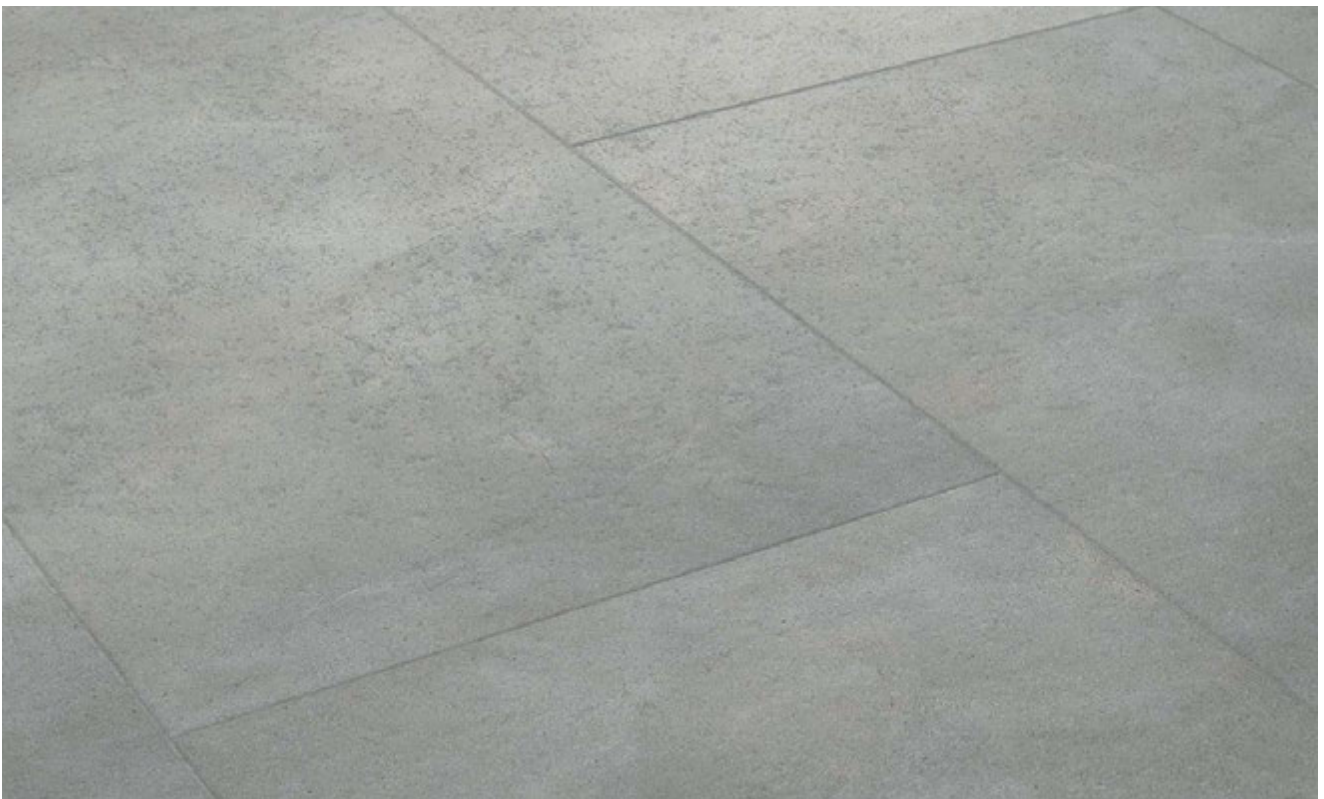
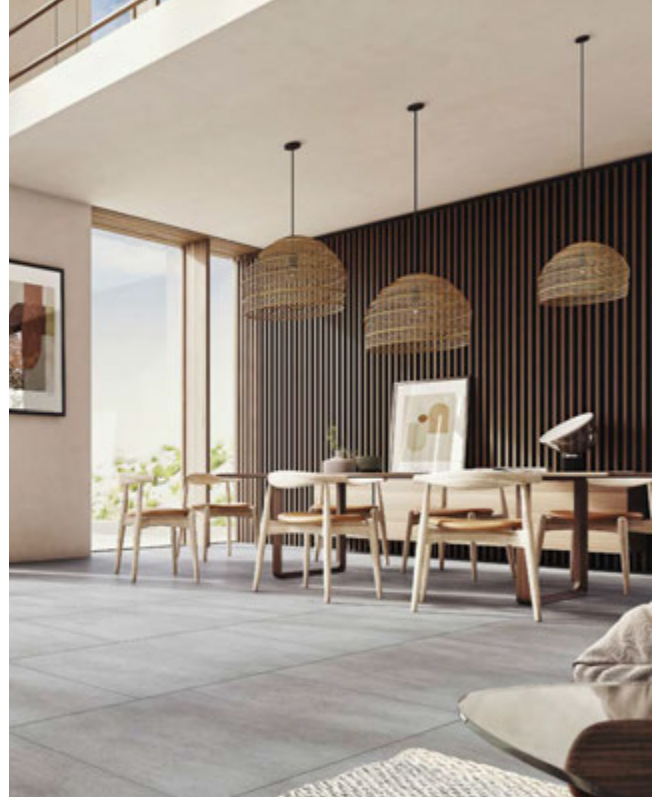

CA 149 / EAN: 5905167814918 / Plank size: 914 mm x 457 mm

1 BOX = 5  = 2,088 m²

AMARON XXL STONE DESIGN

TOKIO CONCRETE

DEEP BEVELS 



1 BOX = 5  = 2,088 m²

CA 150 / EAN: 5905167814925 / Plank size: 914 mm x 457 mm

AMARON XXL STONE DESIGN

BAKER CONCRETE

DEEP BEVELS 



CA 151 / EAN: 5905167814932 / Plank size: 914 mm x 457 mm

1 BOX = 5  = 2,088 m²

AMARON XXL STONE DESIGN

HAMBURG CONCRETE

DEEP BEVELS 



1 BOX = 5  = 2,088 m²

CA 152 / EAN: 5905167814949 / Plank size: 914 mm x 457 mm



LIBERAL

LIBERAL collection in its bright colors in the scandinavian style or warm natural colors will perfectly blend in with every interior. Optically enlarge the room and give the effect of spaciousness. The 2G lock makes the floor is easy and fast to install.

15 years of warranty.



CL_156 | Leonard Oak

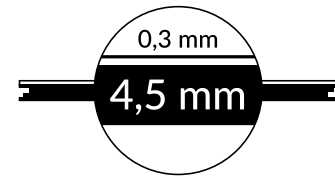
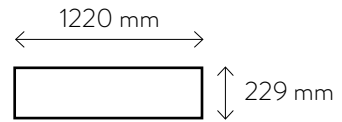
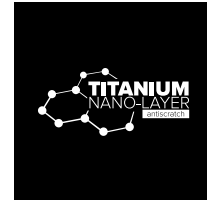

WATCH

THE INSTALLATION VIDEOS ON
www.youtube.com/Arbiton

LIBERAL

ALASKAN OAK

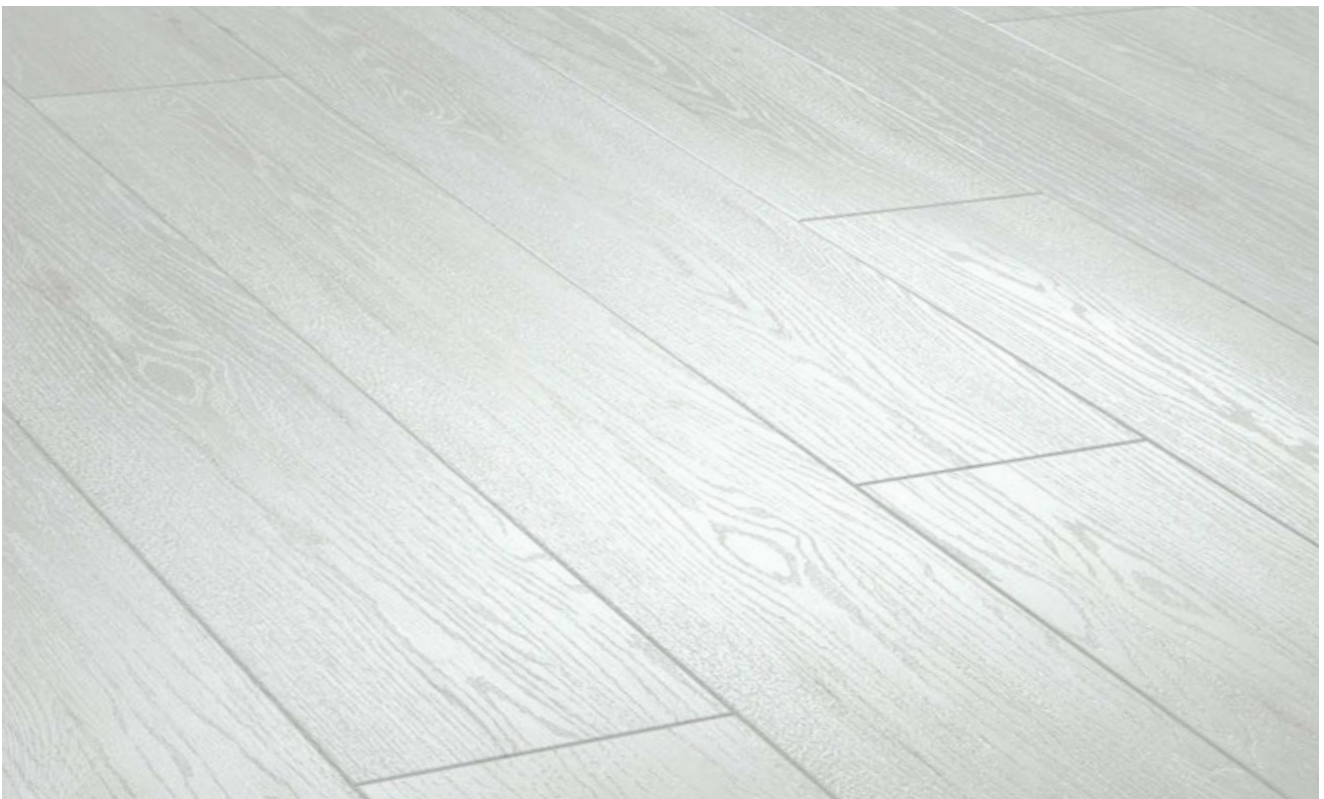
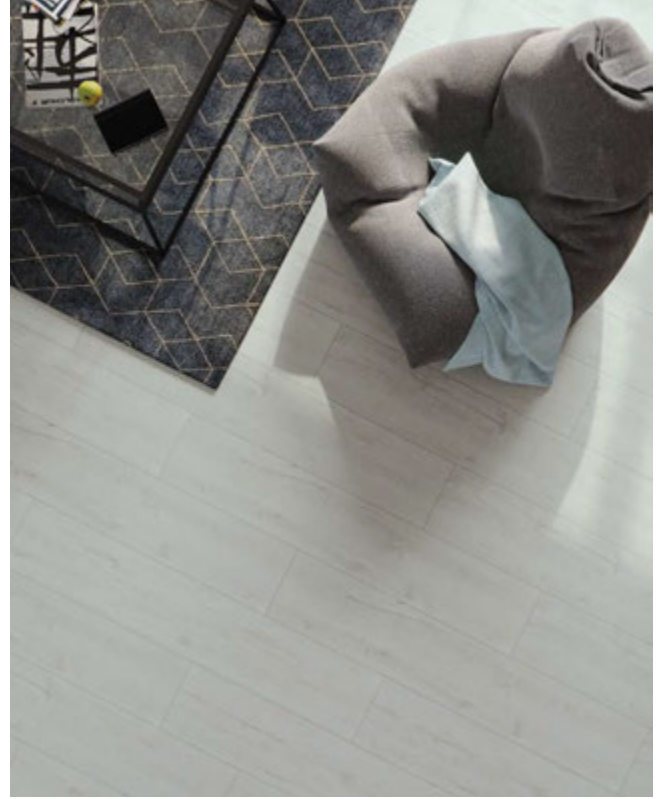

CL 102 / EAN: 5905167798393 / Plank size: 1220 mm x 229 mm

1 BOX = 8  = 2,24 m²

LIBERAL CANADIAN OAK

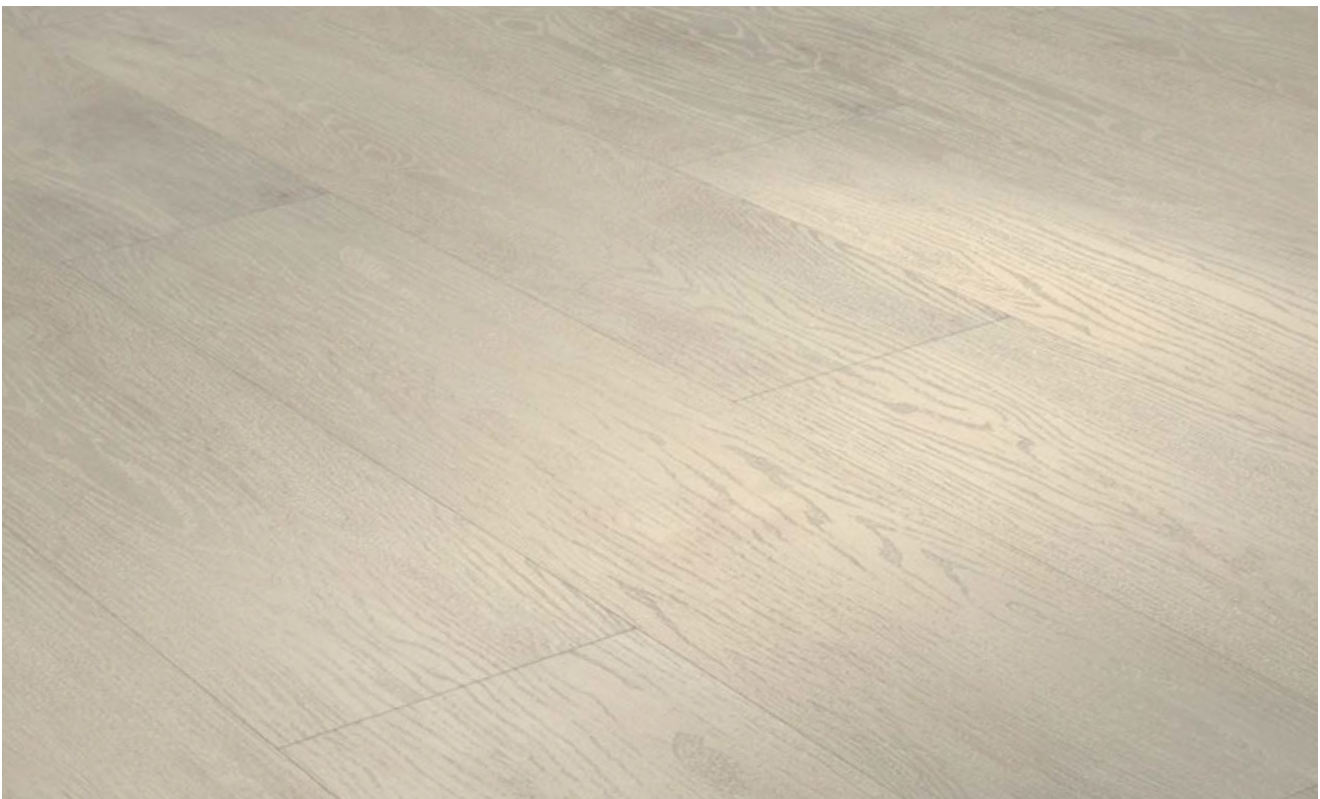

1 BOX = 8  = 2,24 m²

CL 104 / EAN: 5905167798416 / Plank size: 1220 mm x 229 mm

LIBERAL
CONEY OAK

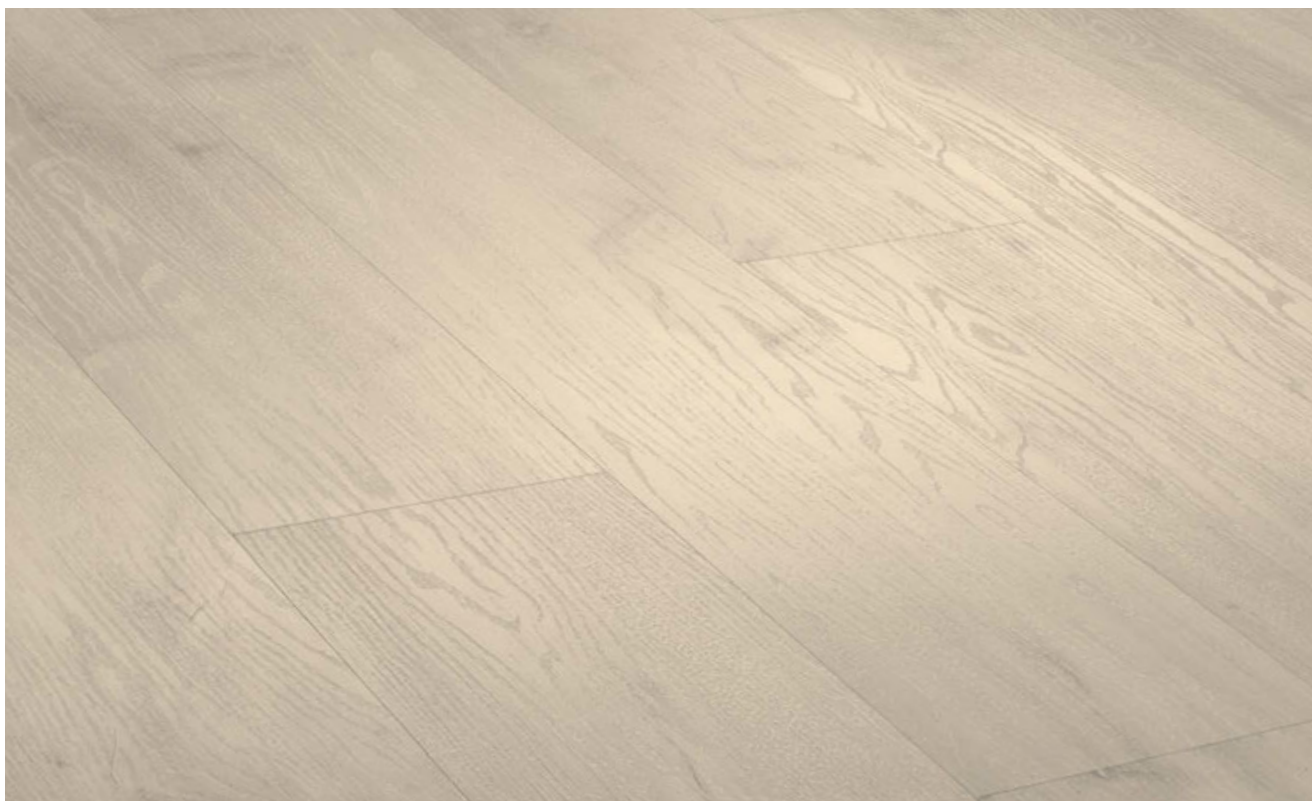

CL 105 / EAN: 5905167798423 / Plank size: 1220 mm x 229 mm

1 BOX = 8  = 2,24 m²

LIBERAL BOLOGNA OAK



1 BOX = 8  = 2,24 m²

CL 112 / EAN: 5905167798492 / Plank size: 1220 mm x 229 mm

LIBERAL
PORTLAND OAK

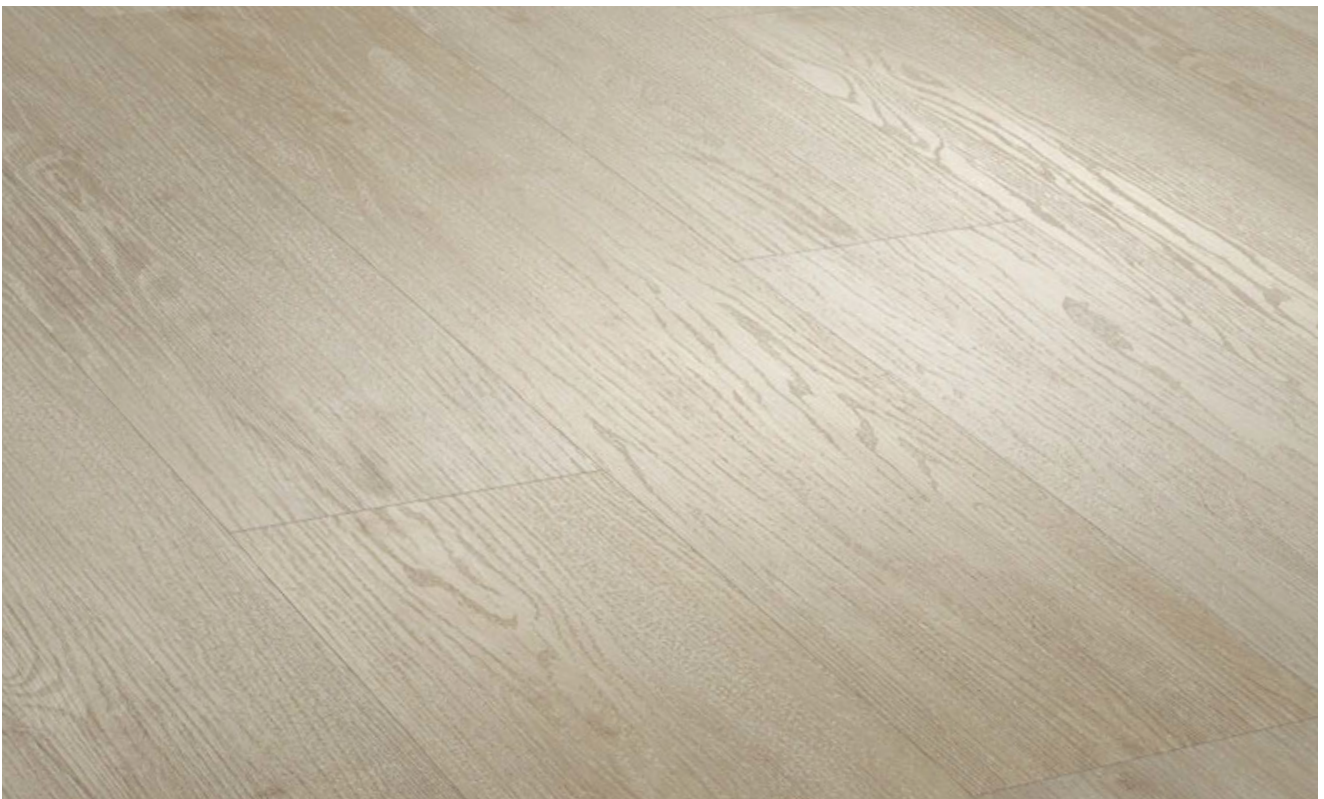

CL 106 / EAN: 5905167798430 / Plank size: 1220 mm x 229 mm

1 BOX = 8  = 2,24 m²

LIBERAL PASADENA OAK



1 BOX = 8  = 2,24 m²

CL 107 / EAN: 5905167798447 / Plank size: 1220 mm x 229 mm

LIBERAL
DAKOTA OAK

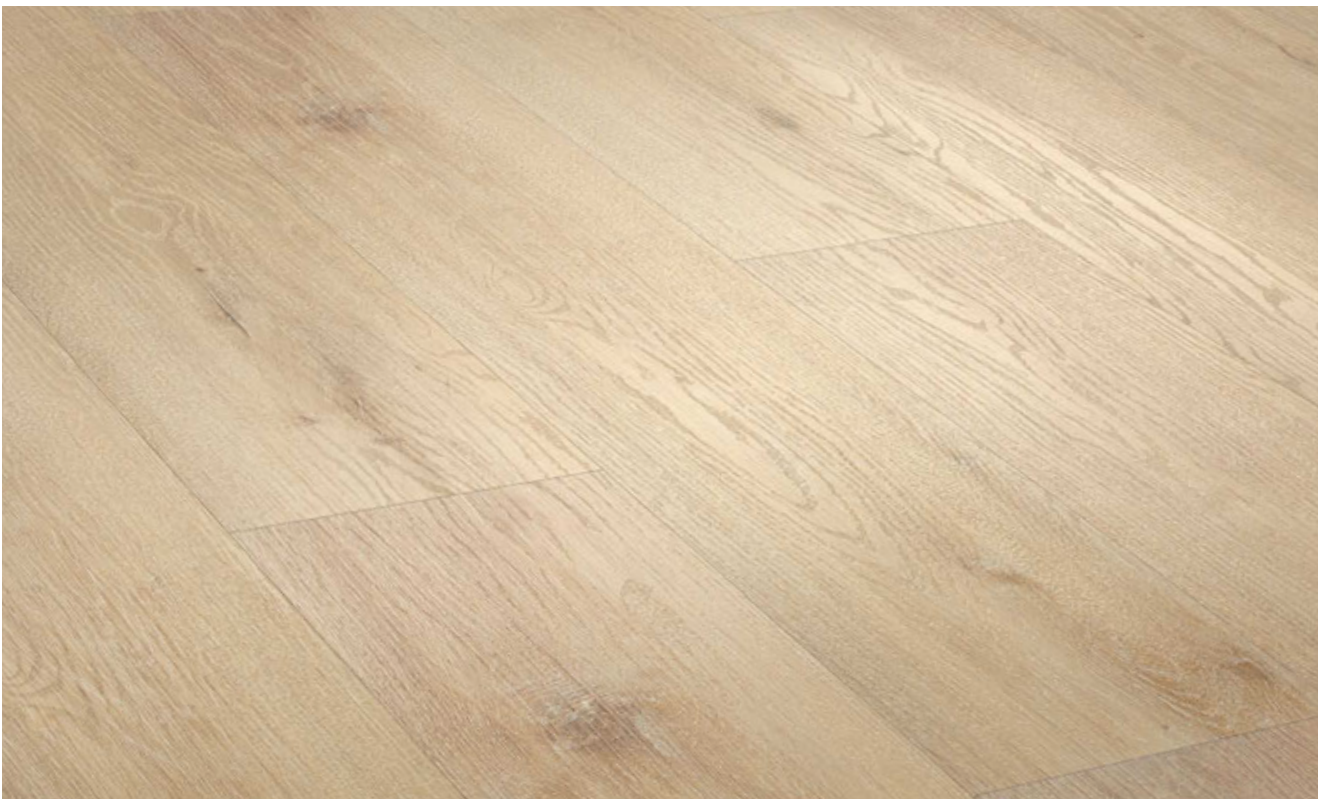
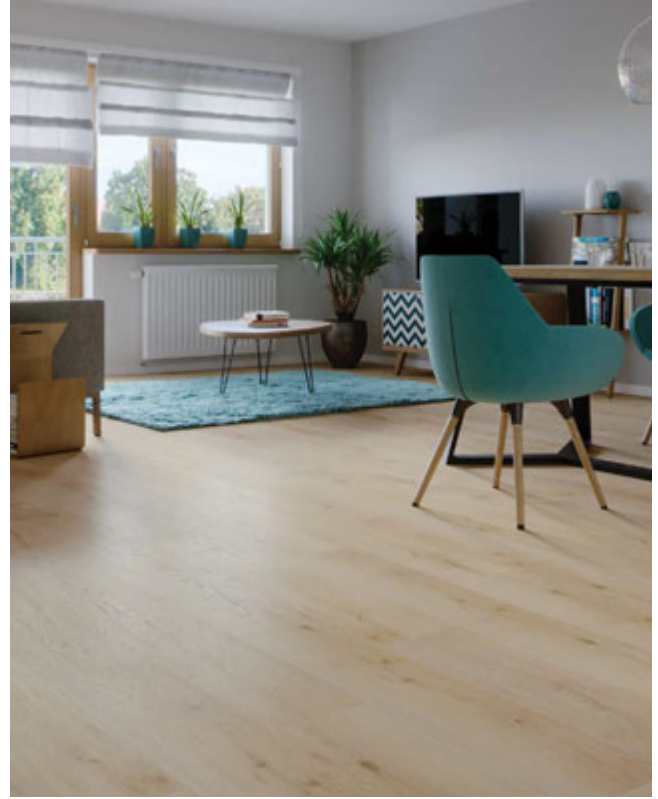

CL 108 / EAN: 5905167798454 / Plank size: 1220 mm x 229 mm

1 BOX = 8  = 2,24 m²

LIBERAL GEORGIA OAK

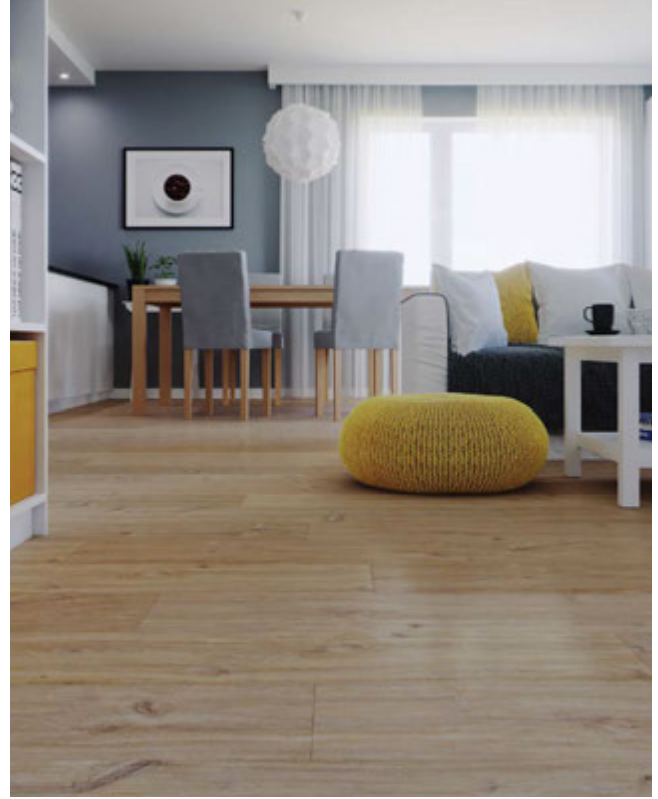

1 BOX = 8  = 2,24 m²

CL 109 / EAN: 5905167798461 / Plank size: 1220 mm x 229 mm

LIBERAL
LEONARD OAK
NEW



CL 156 / EAN: 5905167824221 / Plank size: 1220 mm x 229 mm

1 BOX = 8  = 2,24 m²

LIBERAL
RIDGEFIELD OAK
NEW



1 BOX = 8  = 2,24 m²

CL 157 / EAN: 5905167824238 / Plank size: 1220 mm x 229 mm

LIBERAL
YAKIMA OAK

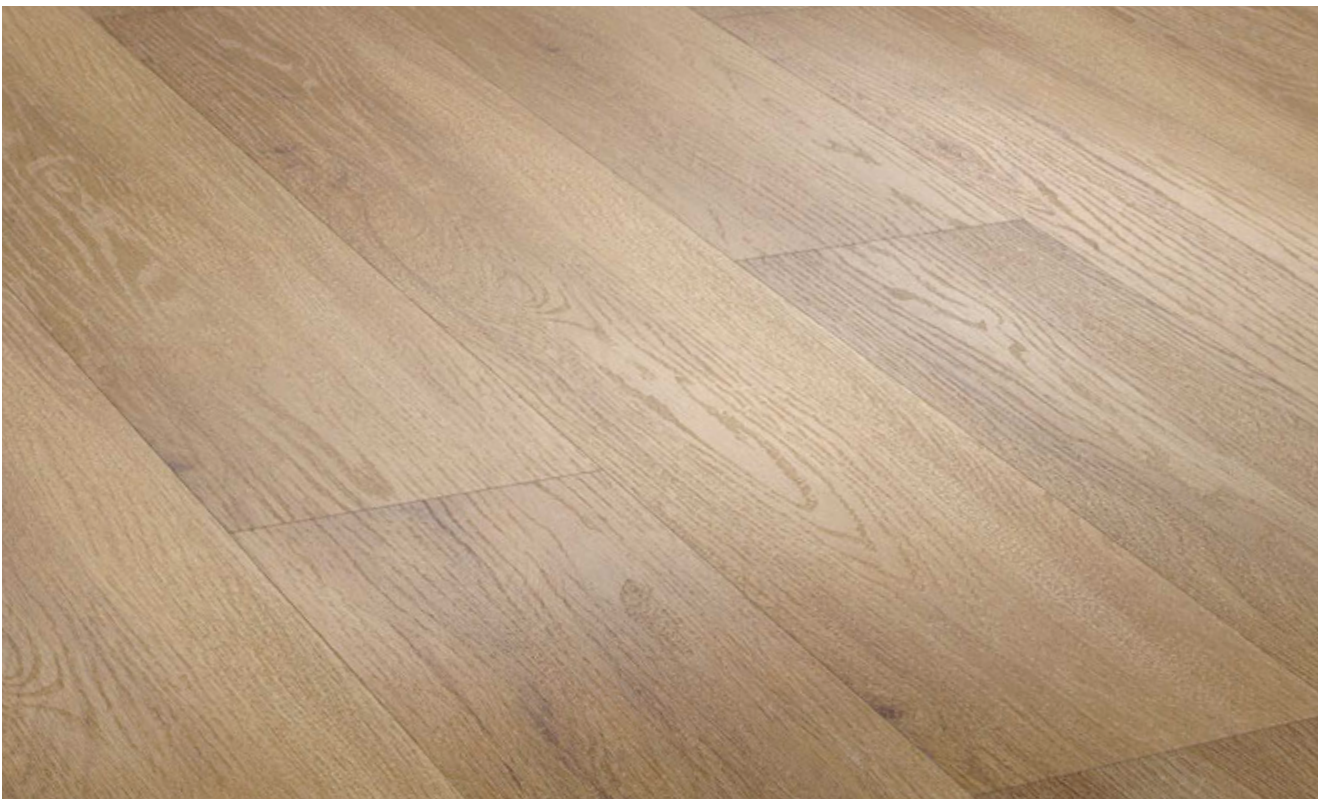
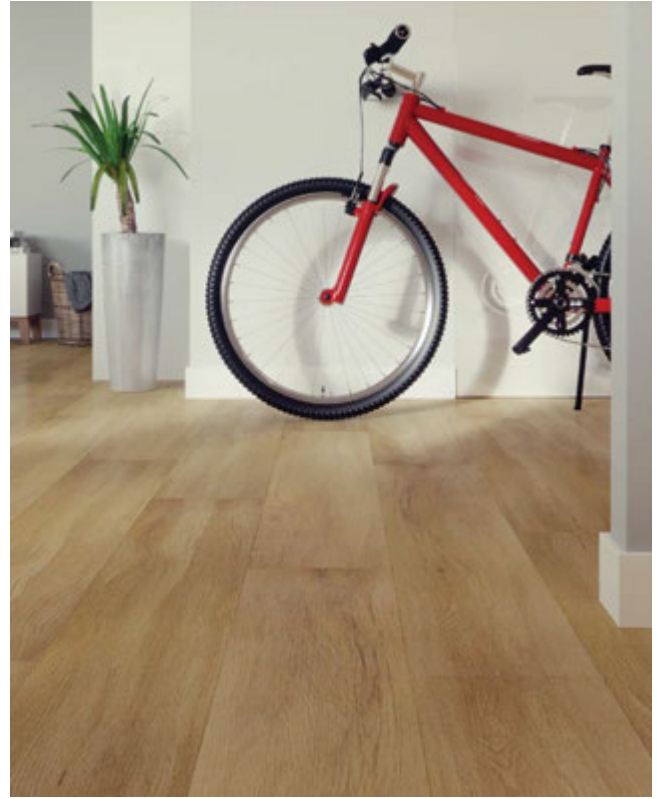

CL 108 / EAN: 5905167798478 / Plank size: 1220 mm x 229 mm

1 BOX = 8  = 2,24 m²

LIBERAL

NEVADA WALNUT

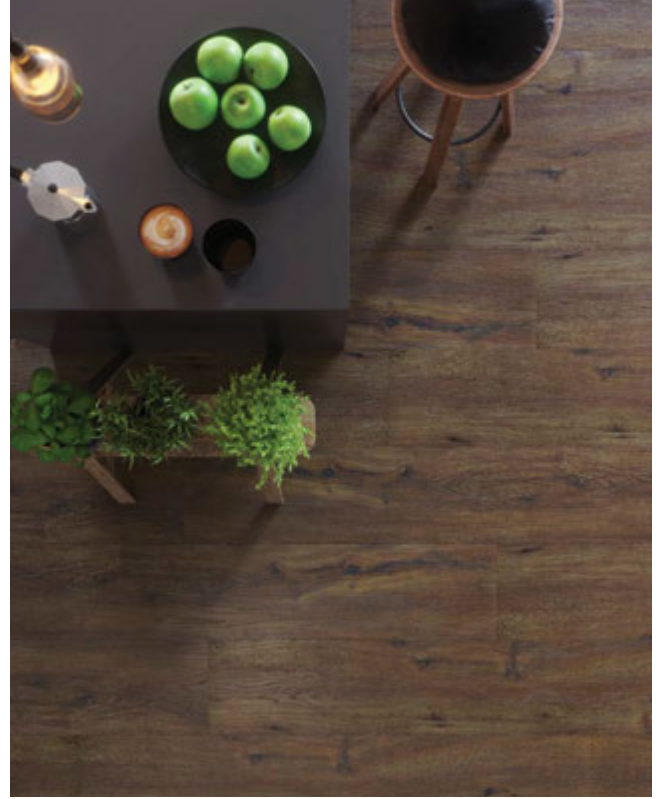

1 BOX = 8  = 2,24 m²

CL 111 / EAN: 5905167798485 / Plank size: 1220 mm x 229 mm



AROQ WOOD DESIGN

AROQ collection have the highest class of uses, created for the most demanding, the mosy-used residential and commercial spaces. The universal coloring of wood and concrete allows you to find a floor wich suits any type of interior.



DA 114 | Williamsburg Oak

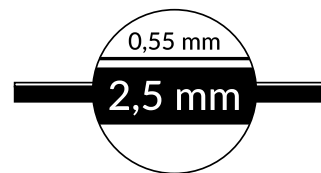
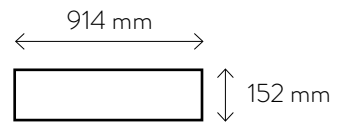

WATCH

THE INSTALLATION VIDEOS ON
www.youtube.com/Arbiton

AROQ WOOD DESIGN

BERGEN OAK



DA 103 / EAN: 5905167798621 / Plank size: 914 mm x 152 mm

1 BOX = 20  = 2,78 m²

AROQ WOOD DESIGN

BOLOGNA OAK



1 BOX = 20  = 2,78 m²

DA 112 / EAN: 5905167798638 / Plank size: 914 mm x 152 mm

AROQ WOOD DESIGN

PASADENA OAK

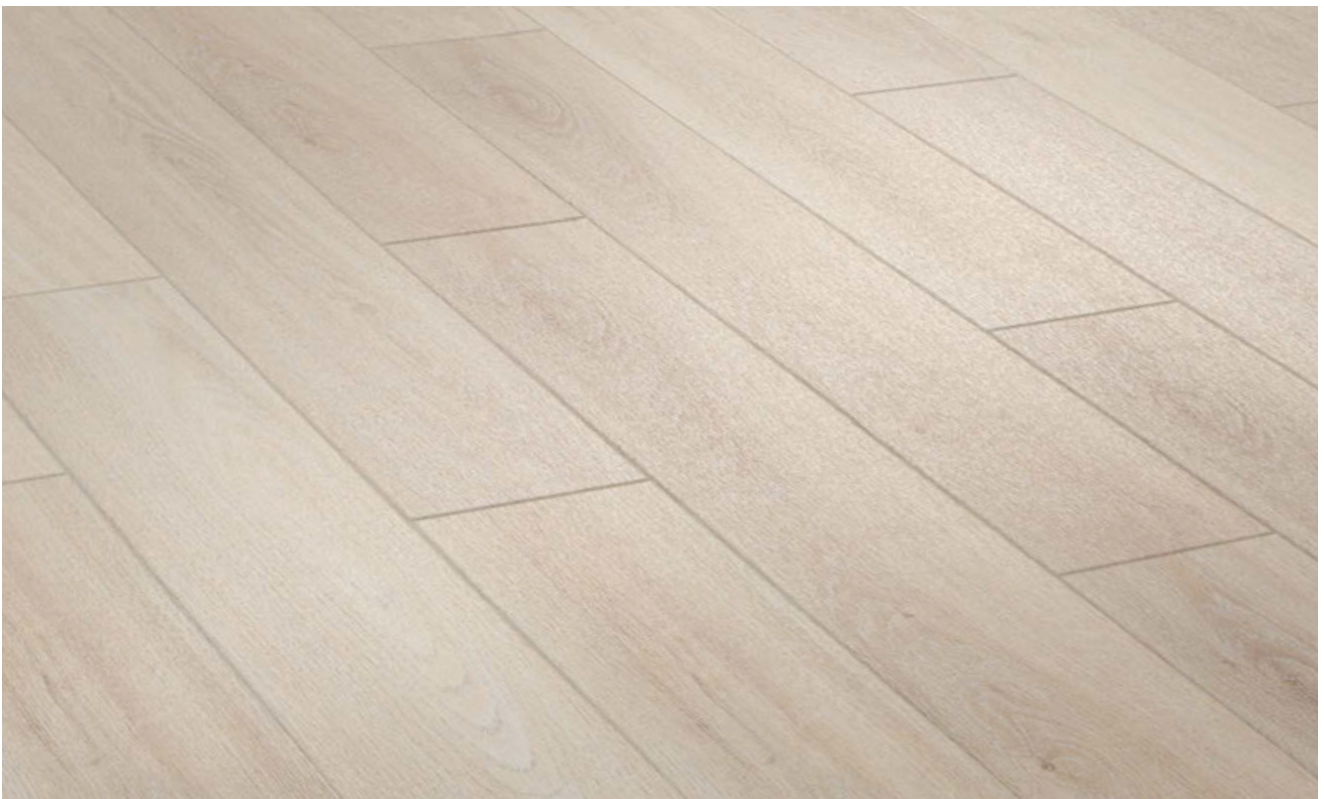
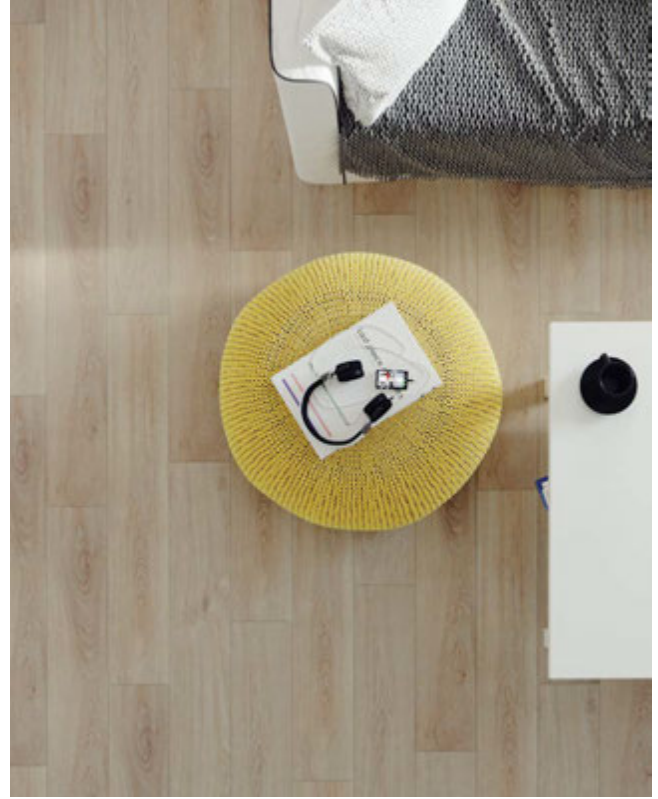



DA 107 / EAN: 5905167798645 / Plank size: 914 mm x 152 mm

1 BOX = 20  = 2,78 m²

AROQ WOOD DESIGN

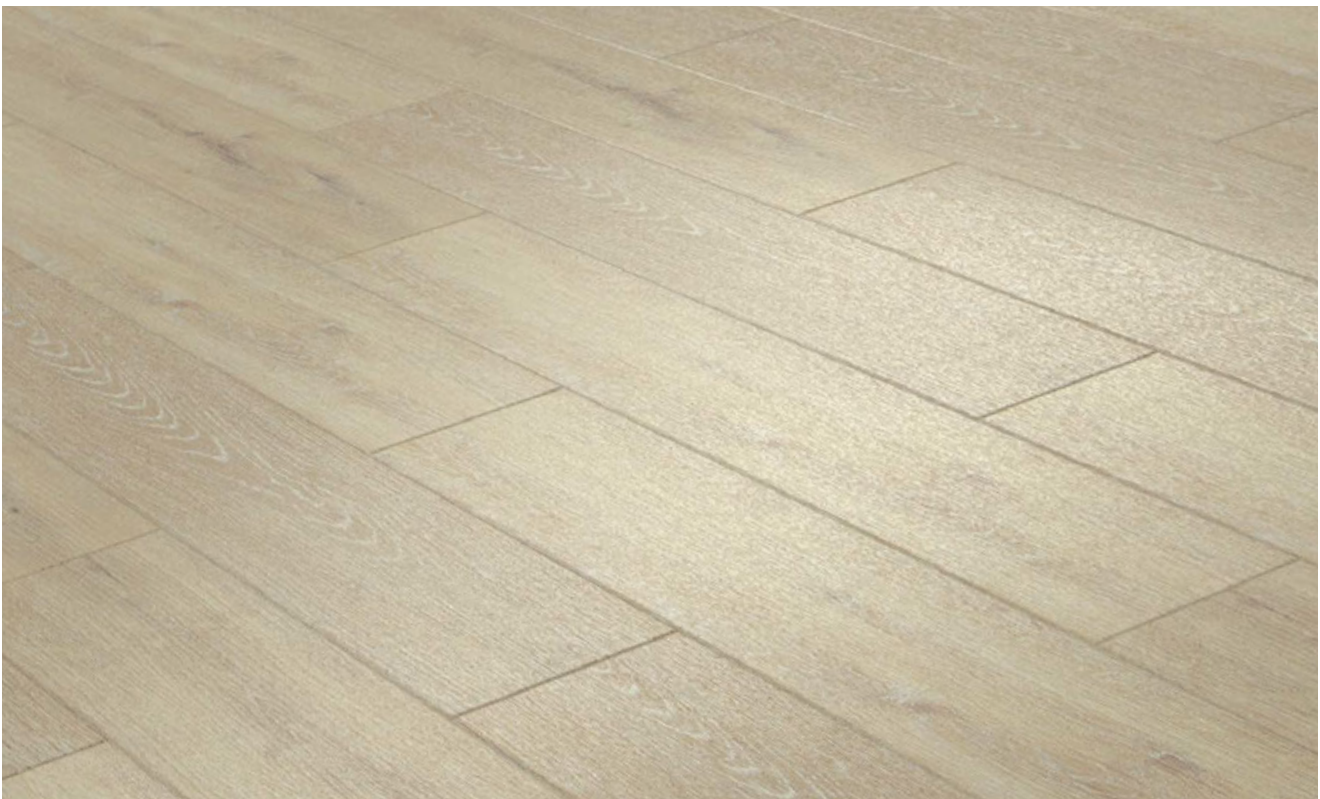
WILIAMSBURG OAK



1 BOX = 20  = 2,78 m²

DA 114 / EAN: 5905167798652 / Plank size: 914 mm x 152 mm

AROQ WOOD DESIGN

NEVADA WALNUT

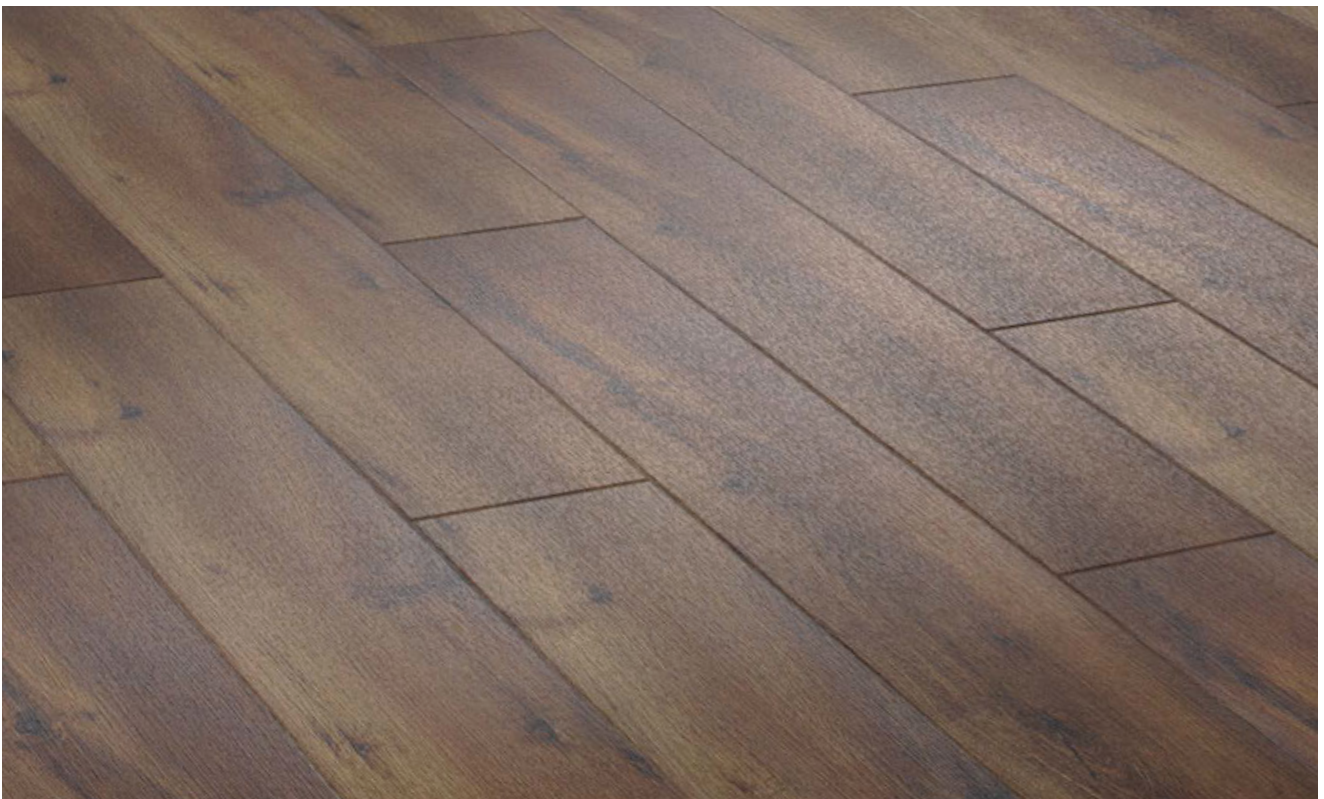

DA 111 / EAN: 5905167798669 / Plank size: 914 mm x 152 mm

1 BOX = 20  = 2,78 m²

AROQ WOOD DESIGN

CAMDEN OAK



1 BOX = 20  = 2,78 m²

DA 124 / EAN: 5905167798676 / Plank size: 914 mm x 152 mm



AROQ STONE DESIGN

AROQ collection have the highest class of uses, created for the most demanding, the mosy-used residential and commercial spaces. The universal coloring of wood and concrete allows you to find a floor wich suits any type of interior.



DA 118 | Soho Concrete

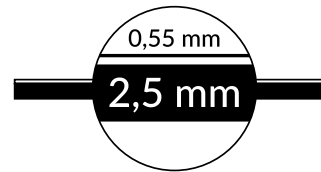
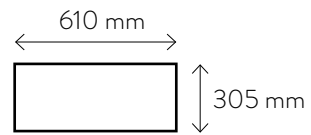

WATCH

THE INSTALLATION VIDEOS ON
www.youtube.com/Arbiton

AROQ STONE DESIGN

SOHO CONCRETE

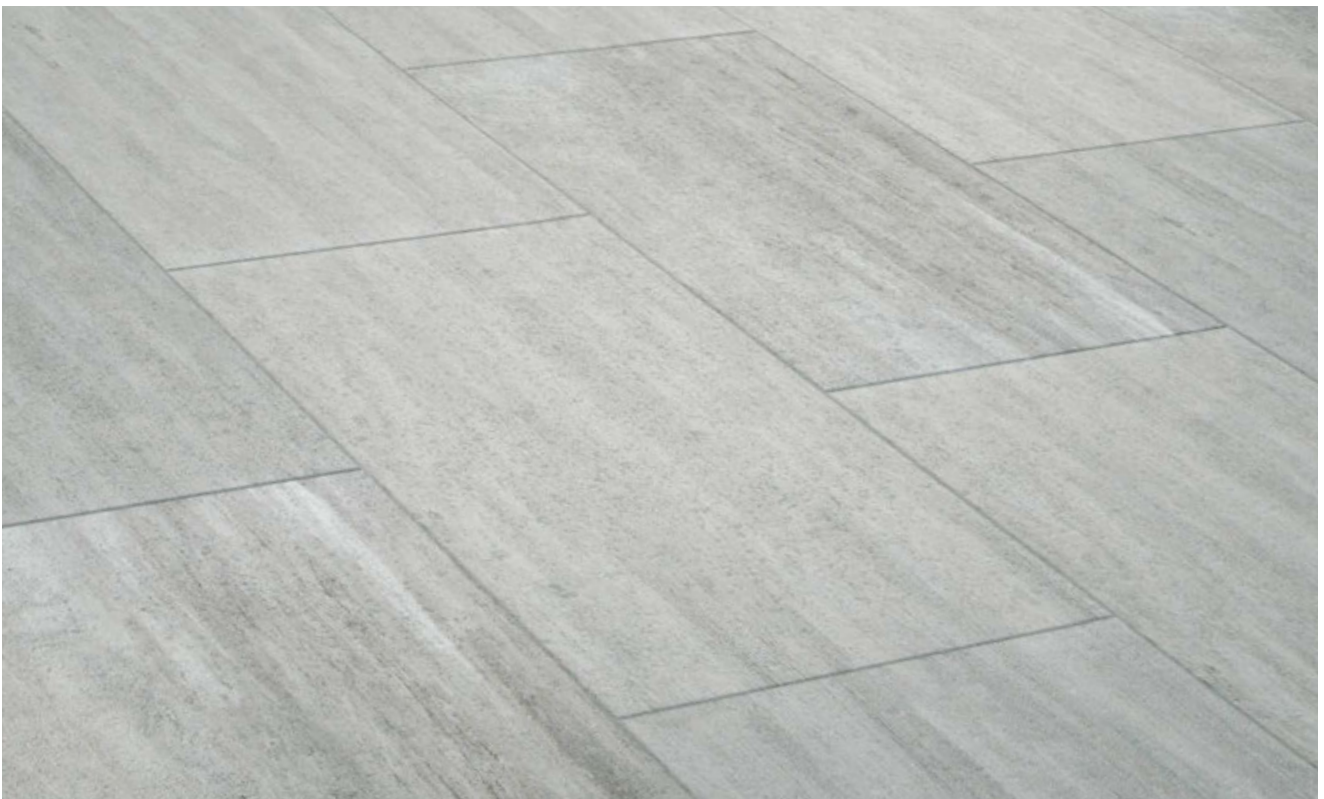



DA 118 / EAN: 5905167798560 / Plank size: 610 mm x 305 mm

1 BOX = 20  = 3,72 m²

AROQ STONE DESIGN

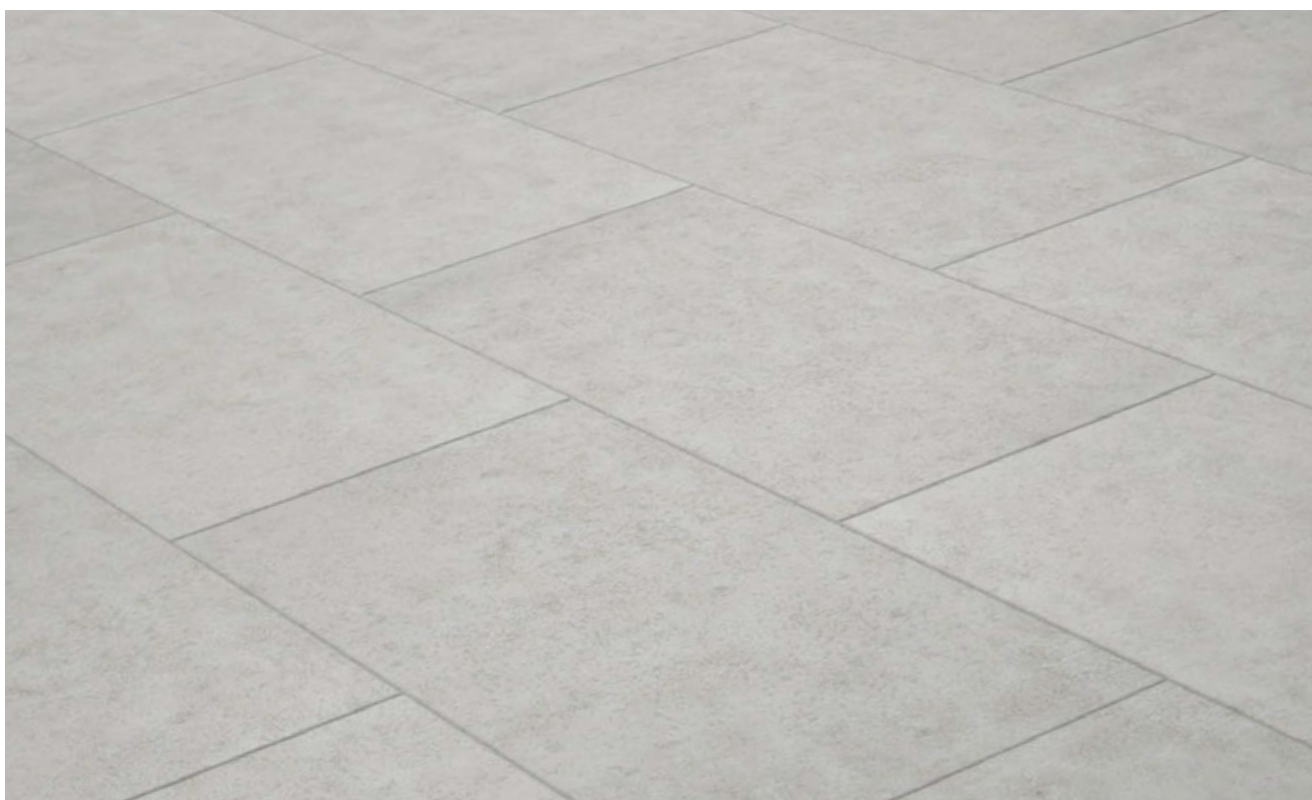
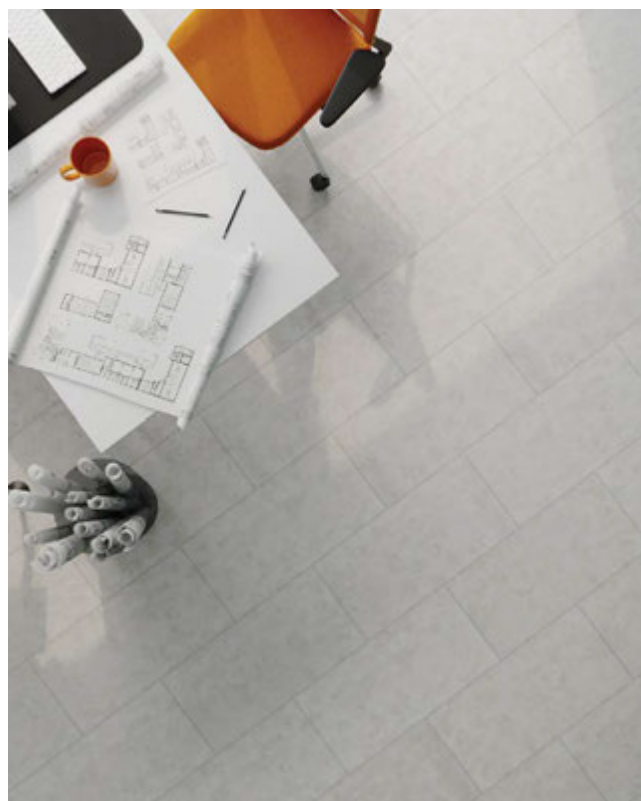
TORONTO CONCRETE



1 BOX = 20  = 3,72 m²

DA 119 / EAN: 5905167798584 / Plank size: 610 mm x 305 mm

AROQ STONE DESIGN

MIAMI CONCRETE



DA 120 / EAN: 5905167798591 / Plank size: 610 mm x 305 mm

1 BOX = 20  = 3,72 m²

AROQ STONE DESIGN

BROOKLYN CONCRETE

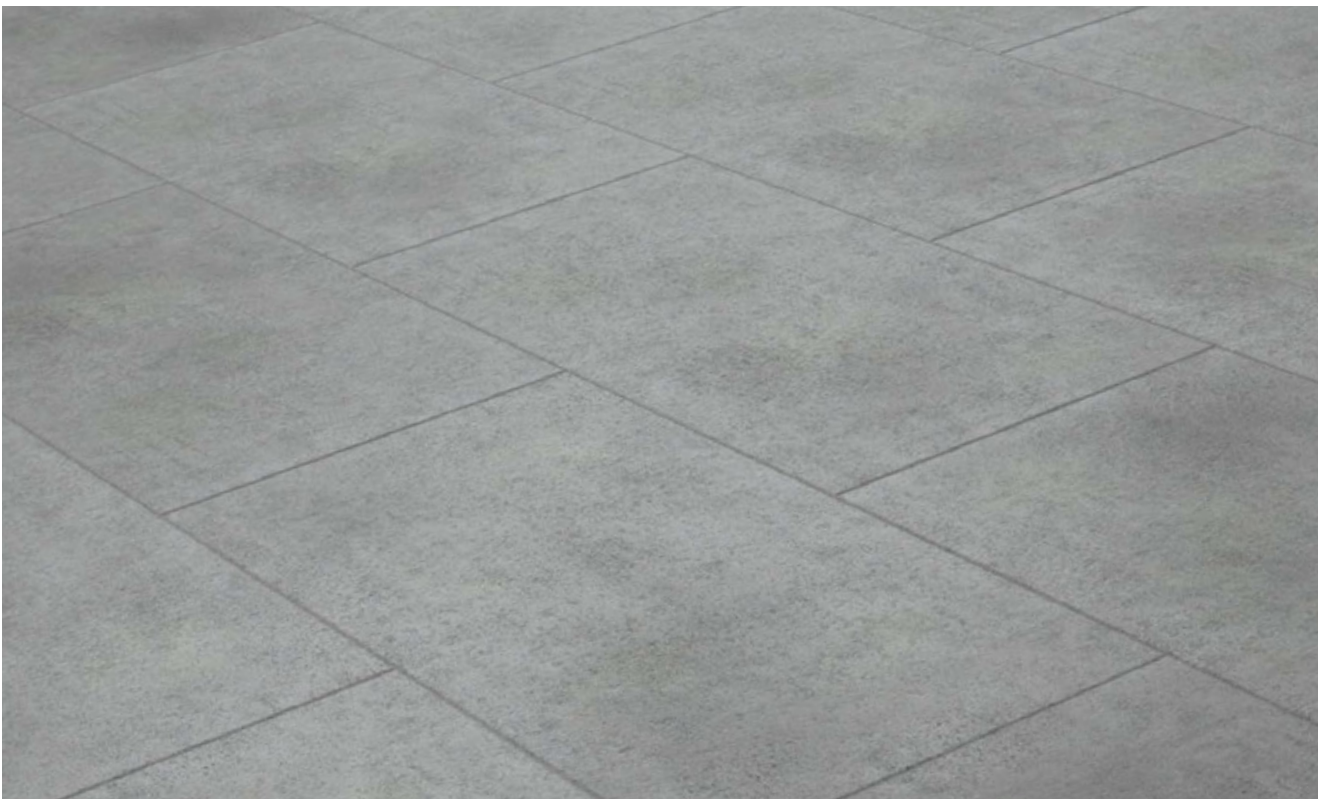

1 BOX = 20  = 3,72 m²

DA 121 / EAN: 5905167798607 / Plank size: 610 mm x 305 mm

AROQ STONE DESIGN

BROADWAY CONCRETE

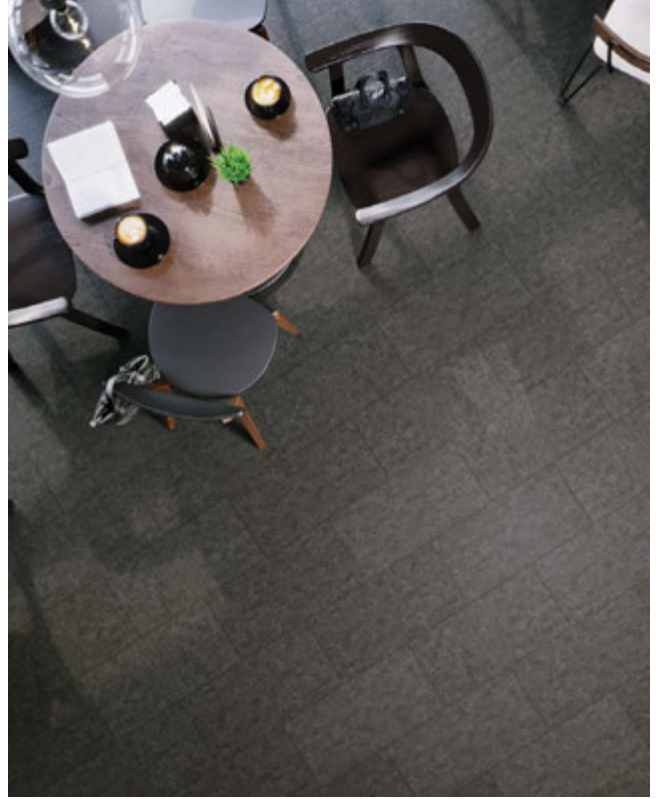



DA 122 / EAN: 5905167798614 / Plank size: 610 mm x 305 mm

1 BOX = 20  = 3,72 m²

AROQ STONE DESIGN

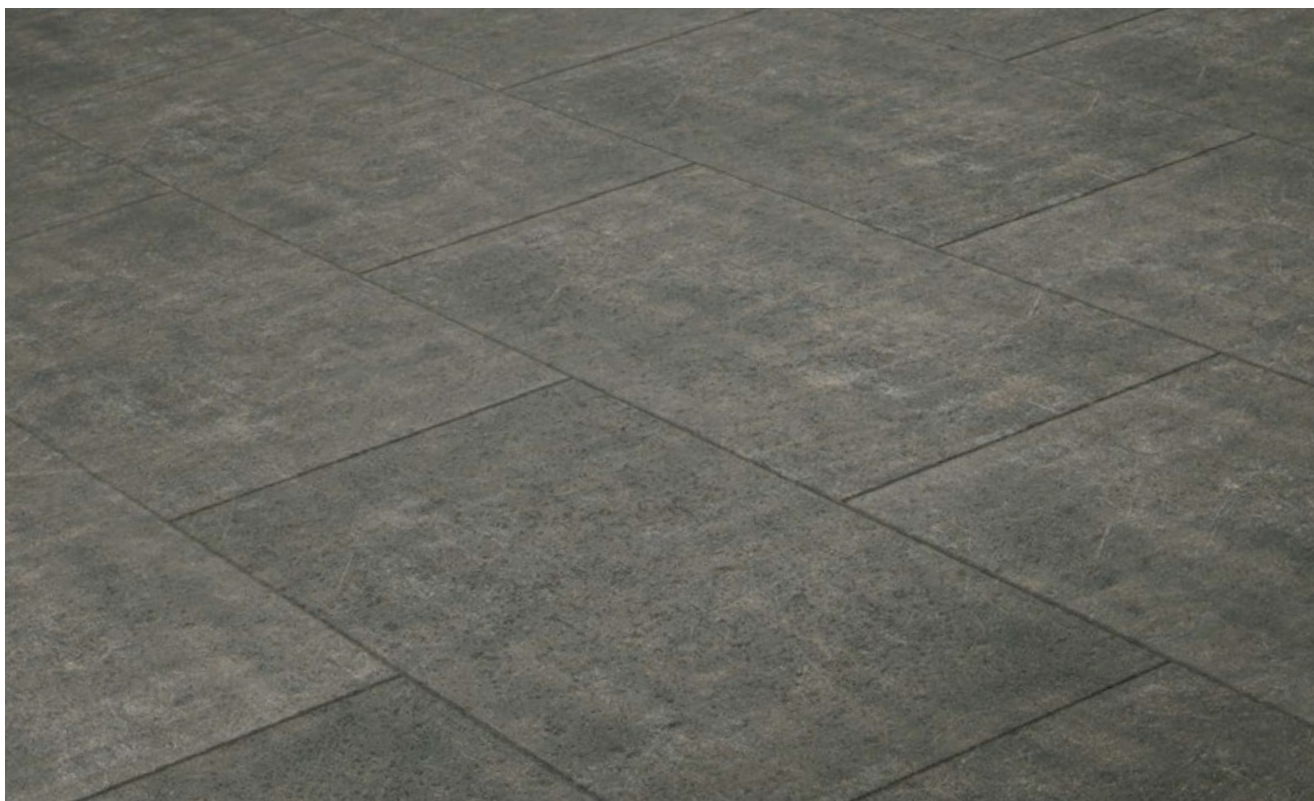
MANHATTAN CONCRETE



1 BOX = 20  = 3,72 m²

DA 123 / EAN: 5905167798577 / Plank size: 610 mm x 305 mm

DESIGN IS IN THE DETAIL

Arbiton is a well-known brand specialized in technologically advanced floor accessories. Our floor system is designed from scratch in every detail. We provide dedicated:

UNDERLAYS - Multiprotec LVT as a perfect harmony with features of HD Mineral Core and Multiprotec LVT Fastlay HD as a revolutionary fast Dryback floor installation. We can also officially recommend Ewifoam underlays, like Vinclic Standard.

perfectly matched **SKIRTING BOARDS** in modern shapes and two sizes – 60 mm and 80 mm

comprehensive floor **PROFILES SYSTEM**

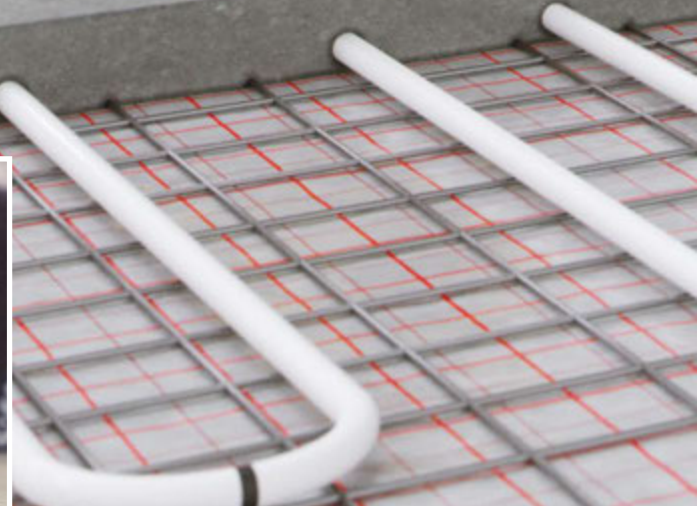



BECAUSE WE CARE ABOUT EVERY DETAIL. WE ARE THE **FLOOR EXPERT.**

UNDERLAYS

FLOOR HEATING

Ideal above under-floor heating - the lowest heat resistance coefficient.



FLOOR DURABILITY

Highest compressive strength (CS) for installation in high-traffic areas.



2 in 1: substrate with integrated Aquastop vapour barrier

Material: PU/minerals + foil

Reaction to fire: Bfl - s1

Special substrate for LVT panels with click system
For high-traffic rooms (very high heavy-load resistance)
Ideal above under-floor heating (lowest level of heat resistance)



MULTIPROTEC LVT

Dedicated underlay for vinyl floors (LVT or RIGID) with click system. Is the best product for allowing the heat from your underfloor heating. Product has a very low thermal resistance. Recommended for high-traffic rooms - very high heavy-load resistance. The product meets the highest requirements of EN 16354 and the recommendations of MMFA (Multilayer Modular Floor Association).









MULTIPROTEC HARDLAY







Dedicated underlay for vinyl floors (LVT or RIGID) with click system. It has an increased compressive strength. It is possibility installed directly over existing ceramic tiles with no prep. Excellent product for floors with underfloor heating. The product meets the highest requirements of EN 16354 and the recommendations of MMFA (Multilayer Modular Floor Association).



SECURA LVT CLICK SMART N

Dedicated underlay for vinyl floors (LVT or RIGID) with click system. It has an increased compressive strength. It is possibility installed directly over existing ceramic tiles with no prep. Excellent product for floors with underfloor heating. The product meets the highest requirements of EN 16354 and the recommendations of MMFA (Multilayer Modular Floor Association).

Material	PUM/PET	PUM/PET
Thickness	1,4 mm	1,1 mm
Form	Roll	Roll
	8,5 m x 1 m / 8,5 m ²	9 m x 1 m / 9 m ²
	yes	yes
	up to 0,008 m ² K/W	up to 0,004 m ² K/W
	up to 16 dB	up to 14 dB
	up to 400 kPa	up to 500 kPa
	up to 0,5 mm	up to 0,3 mm
	75	75
	EAN 5905167776339	EAN 5905167816912

Material	XPS/PET
Thickness	1,5 mm
Form	Smart
	5,30 m x 1,18 m / 6,25 m ²
	yes
	up to 0,04 m ² K/W
	up to 19 dB
	up to 400 kPa
	up to 1,0 mm
	150
	EAN 5905167816943

Recommended ewifoam underlays: Vinclit Standard, Vinclit Solid, Vinclit Classic Smart N

UNDERLAYS

Install your LVT Dryback floor as a floating floor with the revolutionary Multiprotec LVT Fastlay assembly mat. You don't have to be an experienced glued-floor fitter (even laminate-floor fitters will manage Dryback installation with ease).



Minimum subsoil preparation (eliminates minor unevenness) and much quicker glue assembly. Innovative self-adhesive layer allows corrections up to 30 minutes after floor installation.



UNDERLAY IDEAL FOR DRYBACK FLOORS. IT CAN BE USED FOR QUICK RENOVATION WITHOUT INTERFERENCE IN SUBSOIL.

The surface of the mat is covered with an acrylic emulsion adhesive.

Such adhesives have HIGH INITIAL ADHESION properties, which means that powerful bonds are







created within just 30 minutes, after which the floor can be used safely.

If any mistakes are made, it is recommended that the placement of the panel be changed within 10 minutes from the moment of first contact with the mat. Levels out minor unevenness of the substrate.



MULTIPROTEC LVT FASTLAY HD

MULTIPROTEC LVT FASTLAY HD underlay is a revolutionary solution for installing a glued vinyl floor (DryBack) as a floating floor. The ideal solution for quick renovation - the possibility of laying directly on ceramic tiles. The self-adhesive layer allows for self-assembly and correction in case of badly bonded elements. You can walk on the floor directly after assembly and after 30 minutes you can use it without any worries. Minimum preparations - underlay levels out minor unevenness of the substrate.

Material	PUM/PET
Thickness	1,8 mm
Form	Roll
	6 m x 1 m / 6 m ²
	yes
	up to 0,01 m ² K/W
	up to 17 dB
	up to 500 kPa
	up to 0,6 mm
	75

EAN 5905167816967

Recommended ewifoam underlay: Vinlay Rapid HD

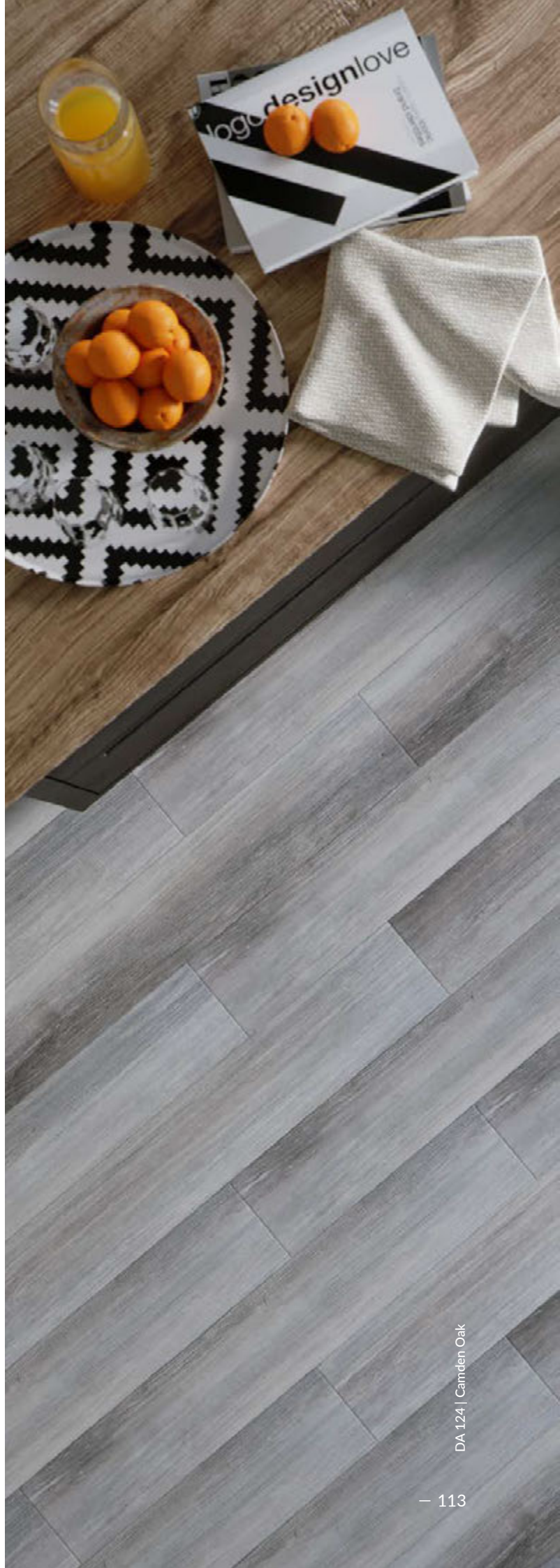

SKIRTING BOARDS



RICH COLOUR PALETTE

Designs of Arbiton skirting boards are adjusted to the current market trends on regular basis. Use of the innovative Printing technology, distinguished by high resolution printing is the guarantee of the highest quality of an image and enables ideal matching of the board and the floor. Decora's technologists have also developed original printing technology - Wood Effect in HD quality - which thanks to the high level of image details allows reproduction of natural wood.





WATERPROOF SOLUTION FOR LVT AND RIGID FLOOR

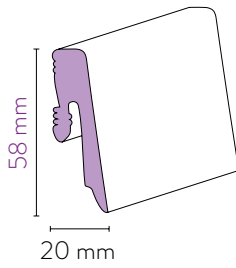
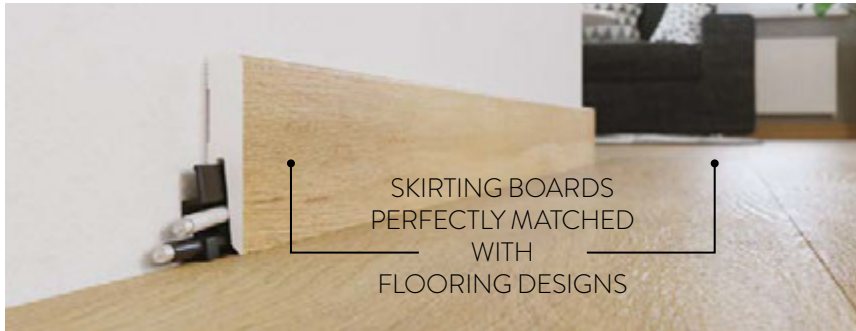

ONE 60

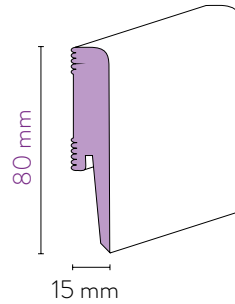

ONE 80

NO.	NAME	EAN
101	Sapporo Oak	5905167803301
102	Alaskan Oak	5905167803318
103	Bergen Oak	5905167803325
104	Canadian Oak	5905167803332
105	Coney Oak	5905167803349
106	Portland Oak	5905167803356
107	Pasadena Oak	5905167803363
108	Dakota Oak	5905167803370
109	Georgia Oak	5905167803387
110	Yakima Oak	5905167803394
111	Nevada Walnut	5905167803400
112	Bologna Oak	5905167803417
113	Panama Oak	5905167803424
114	Williamsburg Oak	5905167803431
115	Oregon Oak	5905167803448
116	Argos Oak	5905167803455
117	Lahti Oak	5905167803462
118	Soho	5905167803479
119	Toronto	5905167803486
120	Miami	5905167803493
121	Brooklyn	5905167803509
122	Broadway	5905167803516
123	Manhattan	5905167803523
124	Camden Oak	5905167803530
145	Wellington Oak	5905167817582
146	Belford Oak	5905167817599
147	Georgetown Oak	5905167817605
148	Grants Oak	5905167817612
149	Glacier Concrete	5905167817629
150	Tokio Concrete	5905167817636
151	Baker Concrete	5905167817643
152	Hamburg Concrete	5905167817650

length: 2,40 m

NO.	NAME	EAN
101	Sapporo Oak	5905167803066
102	Alaskan Oak	5905167803073
103	Bergen Oak	5905167803080
104	Canadian Oak	5905167803097
105	Coney Oak	5905167803103
106	Portland Oak	5905167803110
107	Pasadena Oak	5905167803127
108	Dakota Oak	5905167803134
109	Georgia Oak	5905167803141
110	Yakima Oak	5905167803158
111	Nevada Walnut	5905167803165
112	Bologna Oak	5905167803172
113	Panama Oak	5905167803189
114	Williamsburg Oak	5905167803196
115	Oregon Oak	5905167803202
116	Argos Oak	5905167803219
117	Lahti Oak	5905167803226
118	Soho	5905167803233
119	Toronto	5905167803240
120	Miami	5905167803257
121	Brooklyn	5905167803264
122	Broadway	5905167803271
123	Manhattan	5905167803288
124	Camden Oak	5905167803295
145	Wellington Oak	5905167817667
146	Belford Oak	5905167817674
147	Georgetown Oak	5905167817681
148	Grants Oak	5905167817698
149	Glacier Concrete	5905167817704
150	Tokio Concrete	5905167817711
151	Baker Concrete	5905167817728
152	Hamburg Concrete	5905167817735

length: 2,40 m





STIQ

NO.	NAME	EAN
-----	------	-----

S0611	White	5905167817742
-------	-------	---------------

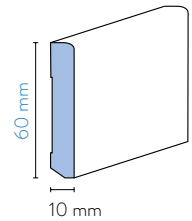

S0810	White	5905167817759
S0810	Light Grey	5905167817766
S0810	Grey	5905167817773

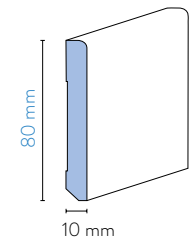

S0820	White	5905167817780
-------	-------	---------------

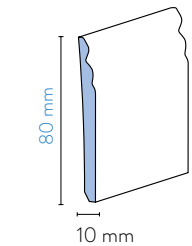

S0950	White	5905167817797
-------	-------	---------------

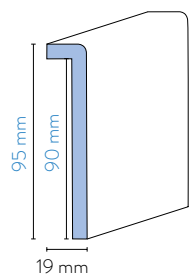

length: 2,40 m

FLOOR PROFILES PRO SYSTEM



B1 | Brushed Silver



B3 | Brushed Titanium



The PRO SYSTEM offer includes precise and elegant solutions of the most common problems. In PRO SYSTEM you will find the perfect masking LVT / RIGID dilatation or aesthetic connection of a hard floor with a carpet. 6 selected shapes - professional solutions has never been so easy.



PRO20

DILATATION OR FINISHING



- CONNECTING FLOORS OF THE SAME LEVEL
- FINISHING AT THE BALCONY DOOR
- ASSEMBLY ON GLUE

length: 0,93 m / 1,86 m

PRO-T

DILATATION



- CONNECTING FLOORS OF THE SAME LEVEL
- ASSEMBLY ON GLUE

length: 0,93 m / 1,86 m

PRODUO22

CONNECTION WITH CARPET



- CONNECTION WITH CARPET AT THE SAME LEVEL
- TWO-PARTS SOLID INSTALLATION SYSTEM
- ASSEMBLY ON GLUE OR SCREWS

length: 0,93 m / 1,86 m

PRO26

LEVELING UP TO 6 mm



- CONNECTING FLOORS WITH SMALL LEVEL DIFFERENCE
- ASSEMBLY ON GLUE

length: 0,93 m / 1,86 m

PROFESSIONAL SOLUTIONS
HAS NEVER BEEN SO EASY

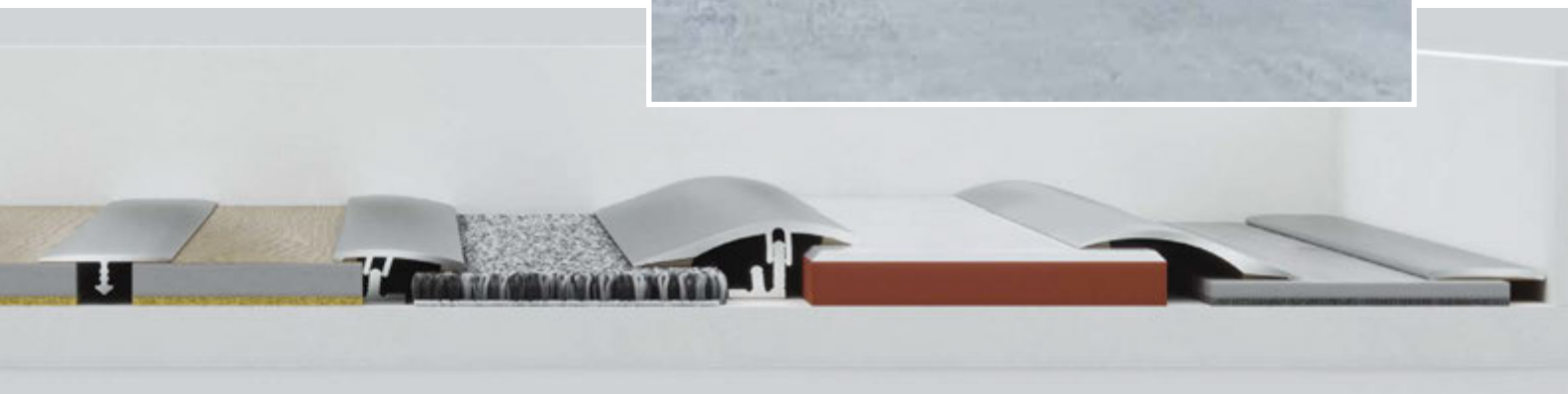

PRO38

LEVELING UP TO 16 mm



- CONNECTING FLOORS WITH HIGH LEVEL DIFFERENCE
- ASSEMBLY ON GLUE

length: 0,93 m / 1,86 m

PRODUO38

LEVELING FLOORS



- CONNECTION OF THE HARD FLOOR WITH CARPETS WITH A LARGE DIFFERENCE IN LEVELS
- TWO-PARTS SOLID INSTALLATION SYSTEM
- ASSEMBLY ON GLUE OR SCREWS

length: 0,93 m / 1,86 m

PRO-L

FINISHING



- FINISHING AT THE BALCONY DOOR OR FURNITURE BASES
- GLUE ASSEMBLY
- DAMP PROOF BARRIER

length: 0,93 m / 1,86 m



FLOOR

COLLECTION	NO.	NAME	EAN
AMARON WOOD DESIGN	CA 102	Alaskan Oak	5905167798508
	CA 117	Lahti Oak	5905167798553
	CA 115	Oregon Oak	5905167798539
	CA 116	Argos Oak	5905167798546
	CA 145	Wellington Oak	5905167814871
	CA 113	Panama Oak	5905167798515
	CA 153	Yankee Oak	5905167824191
	CA 154	Sierra Oak	5905167824207
	CA 146	Belford Oak	5905167814888
	CA 114	Williamsburg Oak	5905167798522
	CA 147	Georgetown Oak	5905167814895
	CA 155	Mayne Oak	5905167824214
	CA 148	Grants Oak	5905167814901
AMARON XXL STONE DESIGN	CA 149	Glacier Concrete	5905167814918
	CA 150	Tokio Concrete	5905167814925
	CA 151	Baker Concrete	5905167814932
	CA 152	Hamburg Concrete	5905167814949
LIBERAL	CL 102	Alaskan Oak	5905167798393
	CL 104	Canadian Oak	5905167798416
	CL 105	Coney Oak	5905167798423
	CL 112	Bologna Oak	5905167798492
	CL 106	Portland Oak	5905167798430
	CL 107	Pasadena Oak	5905167798447
	CL 108	Dakota Oak	5905167798454
	CL 109	Georgia Oak	5905167798461
	CL 156	Leonard Oak	5905167824221
	CL 157	Ridgefield Oak	5905167824238
	CL 110	Yakima Oak	5905167798478
CL 111	Nevada Walnut	905167798485	
AROQ WOOD DESIGN	DA 103	Bergen Oak	5905167798621
	DA 112	Bologna Oak	5905167798638
	DA 107	Pasadena Oak	5905167798645
	DA 114	Williamsburg Oak	5905167798652
	DA 111	Nevada Walnut	5905167798669
	DA 124	Camden Oak	5905167798676
AROQ STONE DESIGN	DA 118	Soho Concrete	5905167798560
	DA 119	Toronto Concrete	5905167798584
	DA 120	Miami Concrete	5905167798591
	DA 121	Brooklyn Concrete	5905167798607
	DA 122	Broadway Concrete	5905167798614
	DA 123	Manhattan Concrete	5905167798577

TECHNICAL PARAMETERS

COLLECTION	DIMENSIONS	THICKNESS	PACK
AMARON WOOD DESIGN	 1511 x 229 mm		1 BOX = 6  = 2,08 m ²
AMARON XXL STONE DESIGN	 914 x 457 mm		1 BOX = 5  = 2,088 m ²
LIBERAL	 1220 x 229 mm		1 BOX = 8  = 2,24 m ²
AROQ WOOD DESIGN	 914 x 152 mm		1 BOX = 20  = 2,78 m ²
AROQ STONE DESIGN	 610 x 305 mm		1 BOX = 20  = 3,72 m ²

BEVELS	INSTALLATION		PERFORMANCE LEVEL			RESIDENTIAL GUARANTEE
	STRONG & SILENT CLICK FLOOR	STRONG CLICK 5G <small>Warranted by Willinge</small>				20* YEARS GUARANTEE RESIDENTIAL
	STRONG & SILENT CLICK FLOOR	STRONG CLICK 5G <small>Warranted by Willinge</small>				20* YEARS GUARANTEE RESIDENTIAL
	STRONG & SILENT CLICK FLOOR	STRONG CLICK 2G <small>Warranted by Willinge</small>				15* YEARS GUARANTEE RESIDENTIAL
	GLUE DOWN VINYL FLOOR					20* YEARS GUARANTEE RESIDENTIAL
	GLUE DOWN VINYL FLOOR					20* YEARS GUARANTEE RESIDENTIAL

Arbiton
FLOOR EXPERT



DECORA GROUP

Decora S.A., ul. Prądzińskiego 24a
63-000 Środa Wlkp., Polska
tel.: +48 61 28 64 200
fax: +48 61 28 54 975
e-mail: sales@decora.pl
www.arbiton.com

GERMANY

ewifoam E. Wicklein GmbH
Stockumer Str. 28
58453 Witten
Tel.: +49 (0) 9261 50 490-0
Fax.: +49 (0) 9261 50 490-50
info@ewifoam.de
www.ewifoam.de

The catalogue is a free of charge presentation of products of Decora S.A. and acc. to valid law it is not a commercial offer. Colors and textures of the products in pictures may differ from real ones because of limited printing technologies. Decora S.A. reserves its right to alter availability of the products on some markets and at some distributors. The products included in the catalogues do not pose a complete offer of Decora S.A.