

SC / SCN

SC / SCN

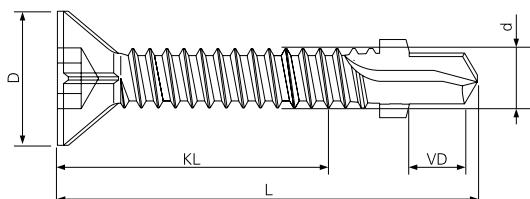

Informations techniques

Matière

Vis

- SC
Acier au carbone, haute qualité
Tête fraisée spéciale

Revêtement de surface

- Zingué blanc
- Autres : sur demande

Tête de vis

- SC2, SC3, SCN2
Empreinte PH2
D = 8 mm

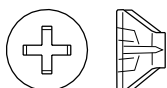

- SC5, SC6, SC8
Empreinte T30
D = 12 mm



- SCN2
Empreinte SR2
D = 8 mm



Exécutions spéciales

Se référer à la dernière page du catalogue pour les quantités minimales

Valeurs techniques

Ø filet	Z _b (N)	Q _b (N)	M _b (N)
4,2	7 400	4 900	450
4,8	9 000	6 000	650
5,5	10 000	8 000	1 000
6,3	17 000	10 000	1 600

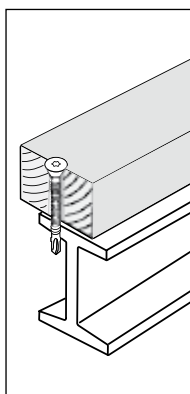
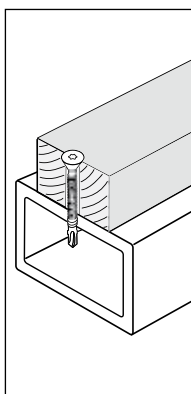
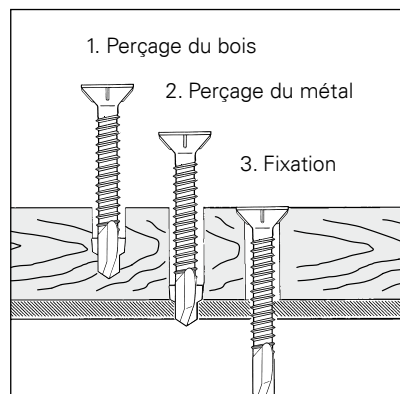

SC2 - Fixation du bois sur ossature acier

■ Acier au carbone

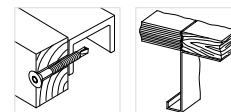

Code Produit	N° article	VD	KL	d x L	Emballage	notes
SC2/21-PH2-4,2X30	844488	2	21	4,2X30	1000	
SC2/31-PH2-4,2X40	844770	2	31	4,2X40	1000	

SCN2 - Fixation du bois sur ossature acier

■ Acier au carbone

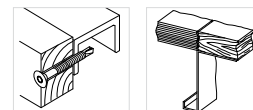
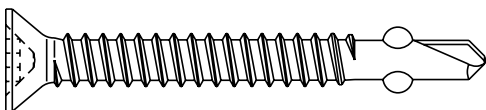

Code Produit	N° article	VD	KL	d x L	Emballage	notes
SCN2/25-SR2-4,2X38	62086	2	25	4,2X38	1000	
SCN2/57-4,2X70	834971	2	57	4,2X70	1000	

SC3 - Fixation du bois sur ossature acier

■ Acier au carbone

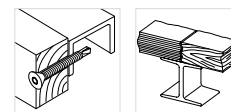
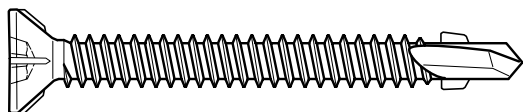

Code Produit	N° article	VD	KL	d x L	Emballage	notes
SC3/25-PH2-4,8X35	844771	3	25	4,8X35	1000	
SC3/35-PH2-4,8X45	1085781	3	35	4,8X45	1000	
SC3/55-PH2-4,8X65-WAX	1068872	3	55	4,8X65	1000	

Outils et accessoires

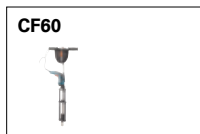

Outils et accessoires décrits au chapitre 9

LÉGENDE

VD Capacité maxi de perçage
KL capacité d'assemblage

d diamètre de filetage
L Longueur sous tête

Dimensions en mm

SC / SCN

1

SC5 - Fixation du bois sur ossature acier

■ Acier au carbone

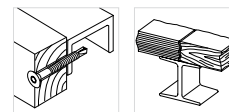
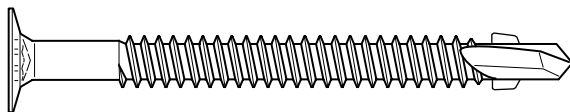

Code Produit	N° article	VD	KL	d x L	Emballage	notes
SC5/24-DS12-5,5X38	713806	5	24	5,5X38	1000	
SC5/31-DS12-5,5X45	713809	5	31	5,5X45	1000	
SC5/36-DS12-5,5X50	713811	5	36	5,5X50	1000	
SC5/41-DS12-5,5X55	1068794	5	41	5,5X55	1000	
SC5/46-DS12-5,5X60	713817	5	46	5,5X60	1000	
SC5/66-DS12-5,5X80	1068860	5	66	5,5X80	500	
SC5/81-DS12-5,5X95	768349	5	81	5,5X95	500	
SC5/101-DS12-5,5X115	676891	5	101	5,5X115	500	
SC5/126-DS12-5,5X140	766186	5	126	5,5X140	100	

SC5 - Fixation du bois sur ossature acier

■ Acier au carbone

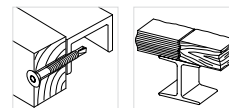
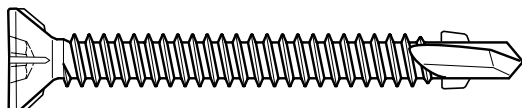

Code Produit	N° article	VD	KL	d x L	Emballage	notes
SC5/24-12-5,5X38	713805	5	24	5,5X38	1000	
SC5/31-12-5,5X45	713807	5	31	5,5X45	1000	
SC5/36-12-5,5X50	713814	5	36	5,5X50	1000	
SC5/41-12-5,5X55	713816	5	41	5,5X55	1000	
SC5/61-12-5,5X75	1068851	5	61	5,5X75	500	

SC5 - Fixation du bois sur ossature acier

■ Acier au carbone

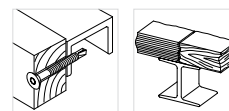
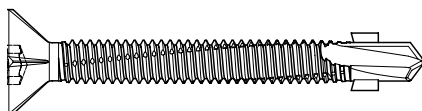

Code Produit	N° article	VD	KL	d x L	Emballage	notes
SC5/25-11-U5,5X38-D	1274161	5	25	5,5X38	1000	
SC5/25-12-U5,5X38-GS08	748316	5	25	5,5X38	1000	
SC5/32-12-U5,5X45-GS08	715183	5	32	5,5X45	1000	

Outils et accessoires

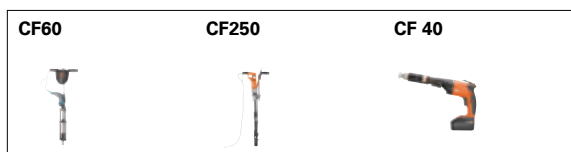

Outils et accessoires décrits au chapitre 9

LÉGENDE

VD Capacité maxi de perçage
KL capacité d'assemblage

d diamètre de filetage
L Longueur sous tête

Dimensions en mm

SC3 - Fixation du bois sur ossature acier

■ Acier au carbone

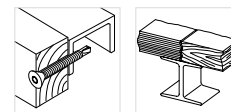
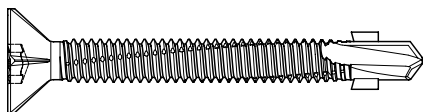

Code Produit	N° article	VD	KL	d x L	Emballage	notes
SC3/20-12/R-U6,3X35-GEOMET	1122378	3	20	6,3X35	1000	

SC6 - Fixation du bois sur ossature acier

■ Acier au carbone

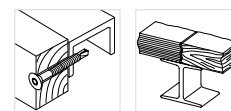
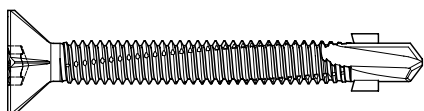

Code Produit	N° article	VD	KL	d x L	Emballage	notes
SC6/29-12-U6,3X45	934066	6	29	U6,3X45	1000	
SC6/34-12-U6,3X50	934068	6	34	U6,3X50	1000	
SC6/39-12-U6,3X55	934070	6	39	U6,3X55	1000	
SC6/44-12-U6,3X60	934071	6	44	U6,3X60	1000	
SC6/49-12-U6,3X65	934072	6	49	U6,3X65	1000	
SC6/54-12-U6,3X70	934074	6	54	U6,3X70	500	
SC6/64-12-U6,3X80	934076	6	64	U6,3X80	500	
SC6/69-12-U6,3X85	934078	6	69	U6,3X85	500	

SC8 - Fixation du bois sur ossature acier

■ Acier au carbone

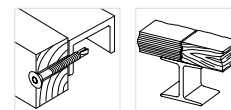
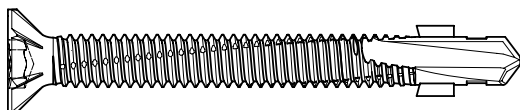

Code Produit	N° article	VD	KL	d x L	Emballage	notes
SC8/42-HP-12-6,3X60	1033858	8	42	6,3X60	500	
SC8/52-HP-12-6,3X70	1018715	8	52	6,3X70	250	
SC8/72-HP-12-6,3X90	1125155	8	72	6,3X90	500	
SC8/92-HP-12-6,3X110	1153552	8	92	6,3X110	250	

Outils et accessoires



Outils et accessoires décrits au chapitre 9

LÉGENDE

VD Capacité maxi de perçage
KL capacité d'assemblage

d diamètre de filetage
L Longueur sous tête

Dimensions en mm