

# INSTRUÇÕES DE MONTAGEM

# liveplace®

## 1 ESCOLHA O SENTIDO DE ABERTURA PRETENDIDO

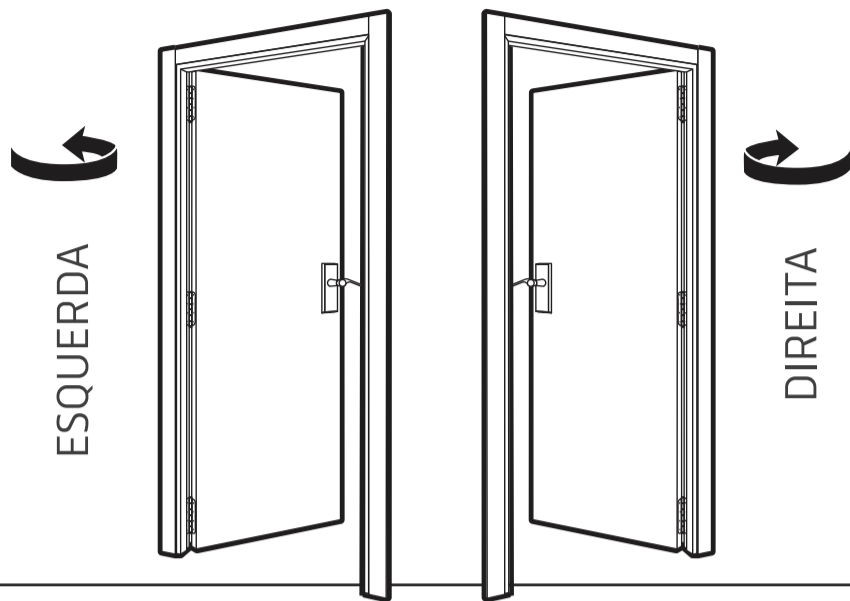

## 2 MEÇA A SUA ESPESSURA DE PAREDE

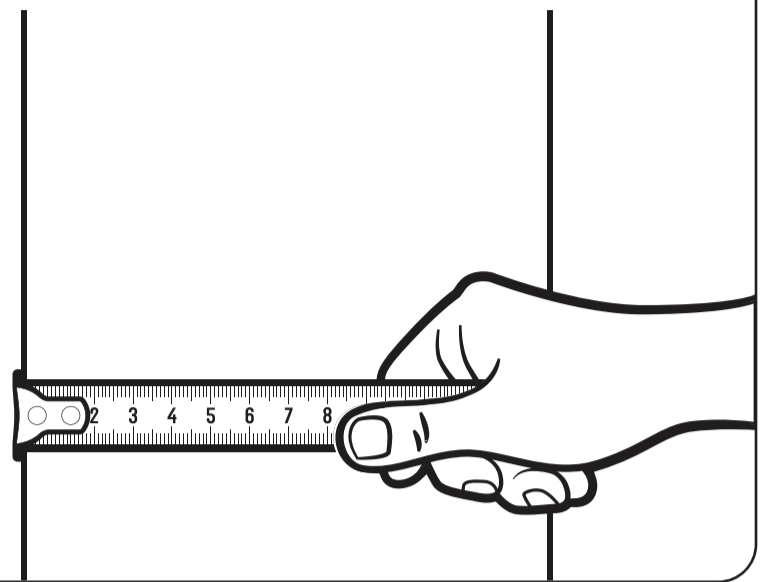

## 3 RECORTE A ADUELA EXTENSÍVEL NO PRÉ-CORTE CORRESPONDENTE NA TABELA

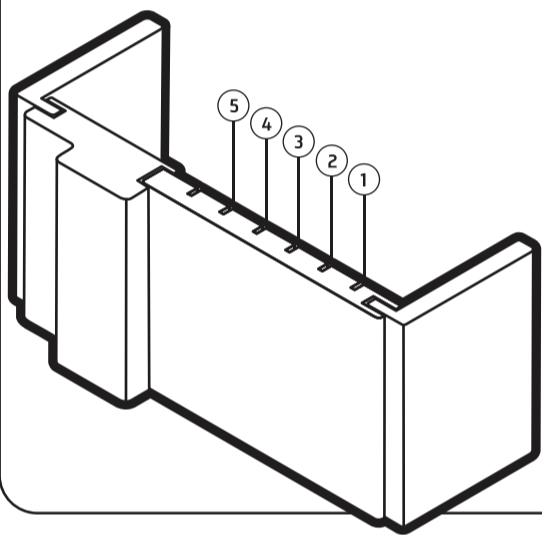

ESPESSURA DE PAREDE	MINIMA mm	MÁXIMA mm
SEM EXTENSÃO	74	88
PRE-CORTE ①	88	108
PRE-CORTE ②	100	120
PRE-CORTE ③	122	142
PRE-CORTE ④	140	160
PRE-CORTE ⑤	158	178

## 4 APARAFUSE AS DOBRADIÇAS NA ADUELA E NA PORTA E INSTALE A PORTA NA ADUELA

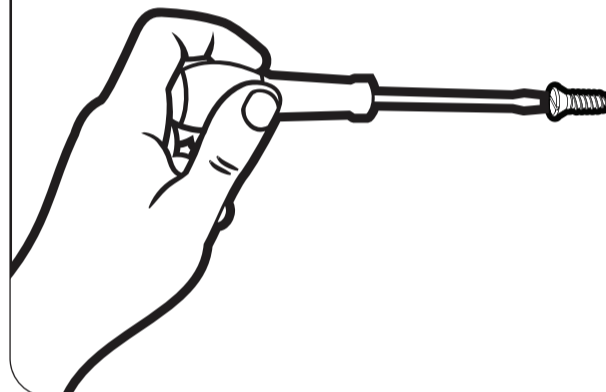

## 5 COLOQUE A PORTA COM ADUELA NO VÃO, FIXANDO BEM COM A AJUDA DE UMAS CUNHAS DE FORMA NIVELADA

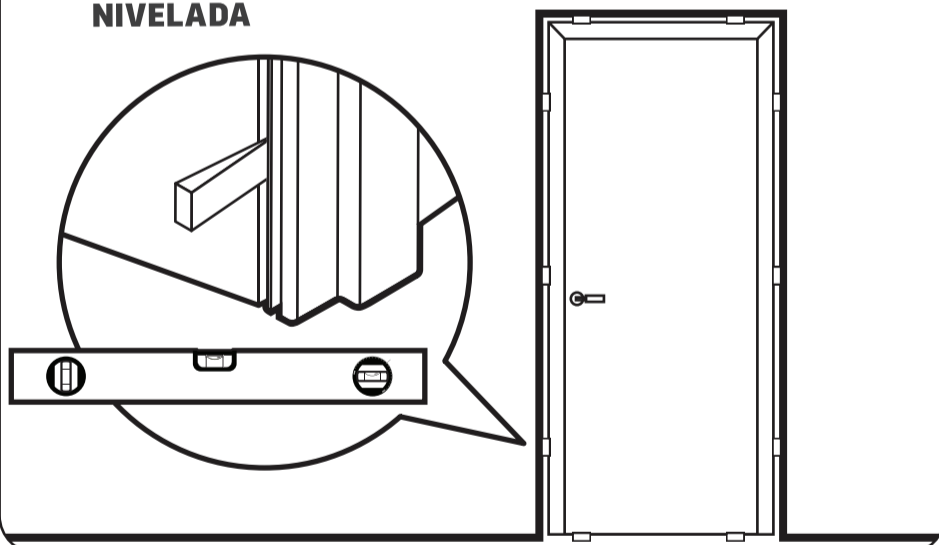

## 6 FIXAR A ADUELA À PAREDE POR INTERMÉDIO DE PARAFUSO OU ESPUMA PU

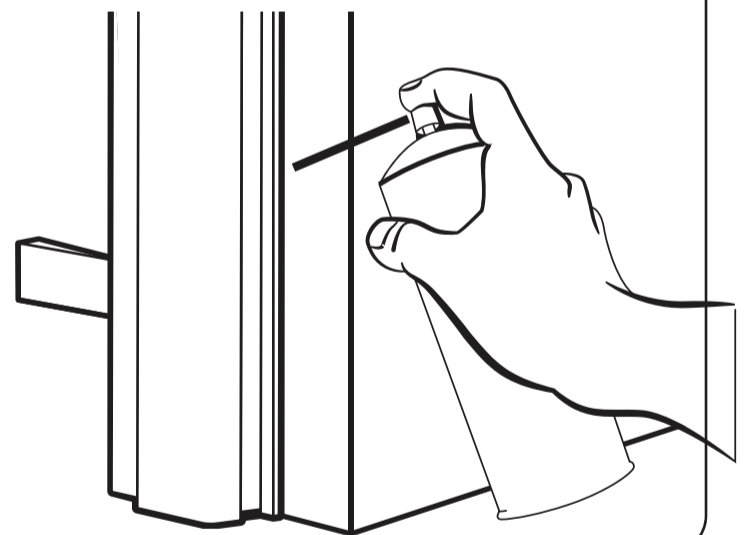

## 5 INSTALE A ADUELA EXTENSÍVEL RECORTADA NA ADUELA FIXA, FIXE COM CUNHAS E ESPUMA DE PU

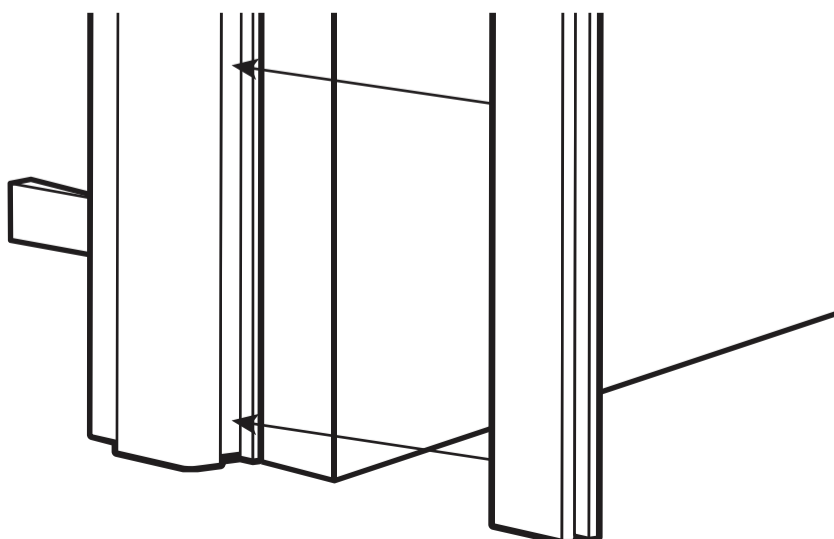

## 6 COLOQUE AS GUARNIÇÕES COM COLA

